

Seminar: Vibrations and Structure-Borne Sound in Civil Engineering – Theory and Applications

Elastic Mounts

Claude Knepper , Andreas Villgrattner

April 22nd, 2006

Abstract

Vibrations are a field of civil engineering because every vibration introduces forces, velocities and displacements into structures. We have to separate the source of vibration from the structure to reduce the negative effect of the vibration. We can obtain a good result by using so called elastic mounts. In this essay we checked two methods which are used in technical literature to calculate the effects of a elastic mount, we see that both lead to similar solutions.

Contents

1	Elastic Mounts	3
1.1	Examples of elastic mounts	
1.2	Single degree of freedom system	
1.3	Results in literature	
2	Impedance	6
1.1	Impedance of a mass	
1.2	Impedance of a damper	
1.3	Impedance of a spring	
1.4	Examples of impedance calculations	
3	Chain system	8
3.1	Chain system calculated with Maple	
4	Longitudinal waves	10
4.1	Pure longitudinal waves	
4.2	Quasi-longitudinal waves	
4.3	Impedance of a beam wave guide	
4.4	Examples	
5	Two degree of freedom system	16
6	Conclusion	17

1 Elastic Mounts

We need elastic mounts to separate machines which cause vibrations from the structure. We have to minimize displacements, forces and velocities of the structures.

1.1 Examples of Elastic Mounts:

- Supports of machines with springs

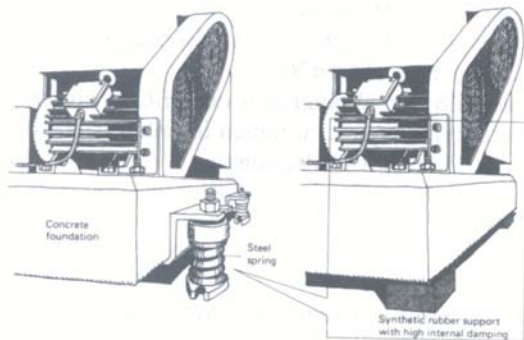

Many machines induce periodic forces into their foundations, which are often caused by unbalanced rotating masses of the engine.

Examples for these machines are:

- washing machines
- dryer
- paper machines
- diesel-engine with alternator
- engine test bench

Picture 1: machine on springs [2]

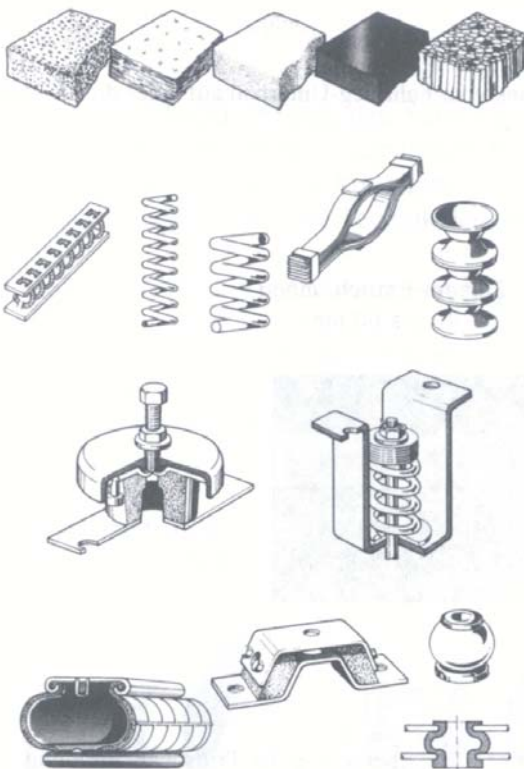

In Picture 2, there are shown some different springs.

Common materials are:

- steel
- rubber
- polystyrene

Similar springs are used in the automotive industry or in aeroplanes. For railways, the method of elastic mounts is applied with a ballast mat under the sleepers and a rubber layer between rail and sleeper.

You can also separate structures like skyscrapers, laboratories, hospitals and buildings with high request of comfort from the ground by using elastic mounts.

Picture 2: spring elements [2]

- Floating floors

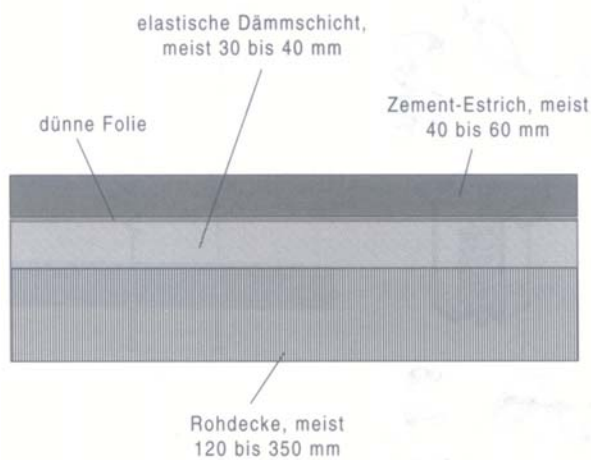

Picture 3: Floating floor [2]

Floating floors are a useful and often used type of elastic mounts. With this soft isolation layer between the cement screed and the ceiling, the introduced forces will not be transmitted into the supporting structure.

Examples for acting forces:

- walking people
- machines like listed above

1.2 Single degree of freedom system (SDOF)

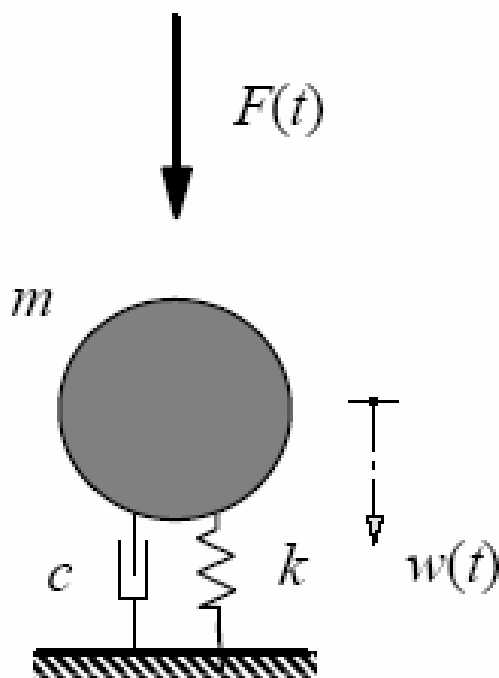

Picture 4: SDOF [1]

In Picture 4 is shown a single degree of freedom system. We explain it because it is used in the following considerations of elastic mounts.

With this very simple model many problems of structural dynamics can be solved.

A sinus-periodic force $F(t)$ is acting on the mass. In our considerations we use:

$$F(t) = F_0 \cdot e^{i\Omega t} \text{ which is equal to}$$

$$F(t) = F_0 \cdot \cos(\Omega \cdot t)$$

(if only the real part is considered)

The parts of this model are:

- mass -> m
- spring -> k
- dashpot -> c
- displacement $w(t)$

- resonance frequency $f_{res} = \sqrt{\frac{k}{m}}$

1.3 Result in literature

Diagrams are used for dimensioning elastic mounts and calculating their impact. In “Technische Akustik” of L.Cremer and M.Möser we found the following diagram:

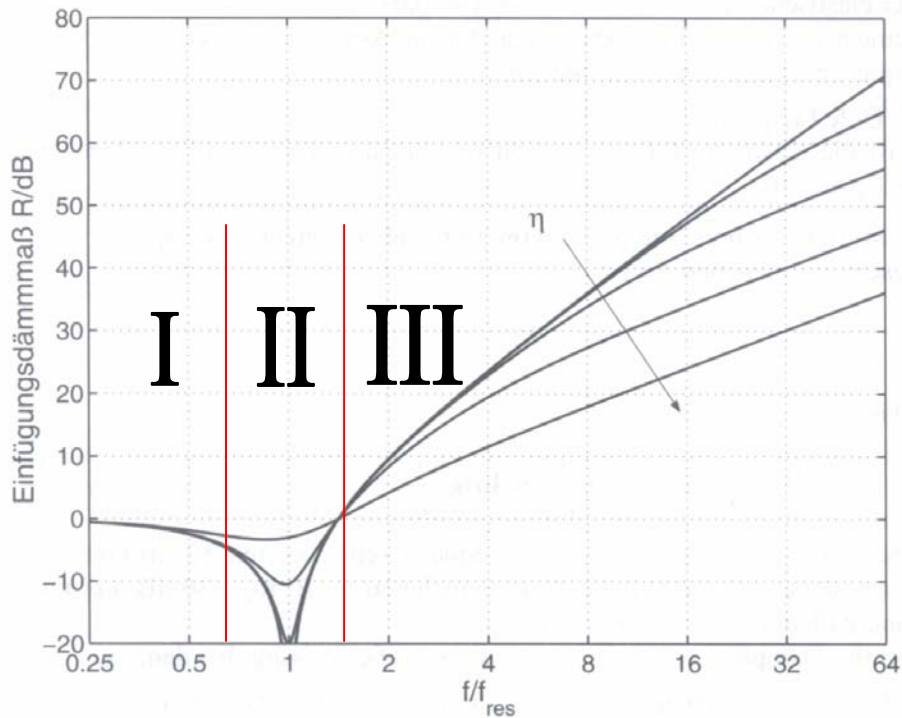

Picture 5: Diagram to prove [2]

On the x-axis it is given the ratio of the frequency of the acting force to the natural frequency of the system. The y-axis describes the insertion loss of the elastic mount, which is defined by the logarithmic ratio of the acting force to the resulting force after the installation of the elastic mount.

For this calculation, we consider a single degree of freedom system, as shown in picture 4. We divide this diagram in three different parts, for better understanding:

- Area I : the results in this frequency band are almost zero.
- Area II : near the resonance frequency, the damping ratio becomes negative which means that the bad effects become worse.
- Area III : with increasing frequency, the damping value increases, too. This is the area you have to obtain.

Before we can start with our investigation results, we have to consider a bit of theory. First of all we need the theory of impedances:

2. Impedance

Impedances are the ratio of the amplitude of an acting force to the amplitude of the velocity of the point where the force is acting.

The constraints of the impedance model are:

- acting forces have to be harmonic
- only the steady state of the oscillation is considered

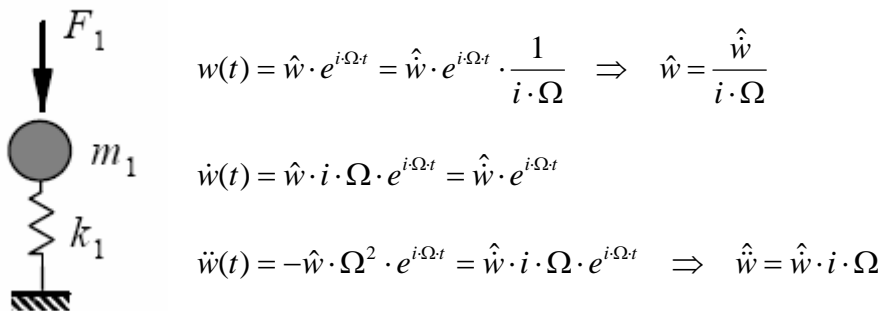

2.1 Impedance of a mass

In the case of a mass you have the same force:

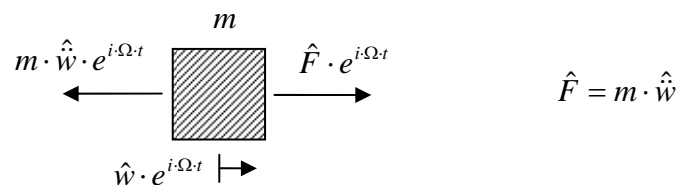

$$Z_m = \frac{\hat{F}}{\hat{w}} = \frac{m \cdot \hat{w}}{\hat{w}} = \frac{\hat{w} \cdot i \cdot \Omega \cdot m}{\hat{w}} = i \cdot \Omega \cdot m$$

2.2 Impedance of a damper

In the case of a damper you have also the same force:

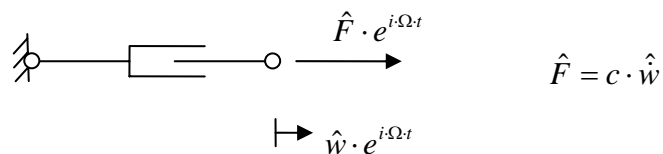

$$Z_c = \frac{\hat{F}}{\hat{w}} = \frac{c \cdot \hat{w}}{\hat{w}} = c$$

2.3 Impedance of a spring

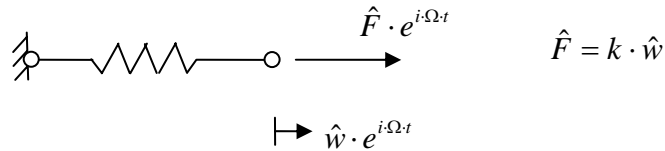

$$\hat{F} = k \cdot \hat{w}$$

$$Z_m = \frac{\hat{F}}{\hat{w}} = \frac{k \cdot \hat{w}}{\hat{w}} = \frac{k \cdot \hat{w}}{i \cdot \Omega \cdot \hat{w}} = \frac{k}{i \cdot \Omega}$$

2.4 Examples of impedance calculation

1. Example

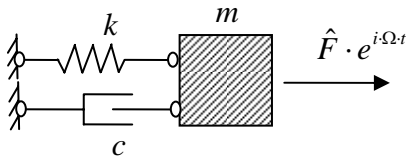

The three elements mass, spring and damper have the same velocity. Therefore every impedance has the same displacement as well.

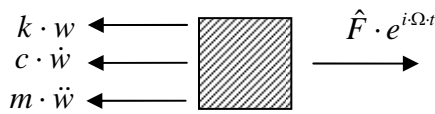

$$Z_w = Z_m + Z_c + Z_k = i \cdot \Omega \cdot m + c + \frac{k}{i \cdot \Omega}$$

2. Example

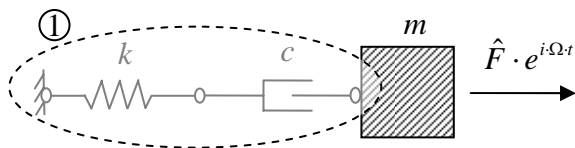

In this system the spring and the damper have the same force. We have to do this in two steps, first, the common impedance of spring and damper, and afterwards the whole impedance including the mass.

$$\frac{1}{Z_1} = \frac{1}{Z_k} + \frac{1}{Z_c} \Rightarrow Z_1 = \frac{1}{\frac{i \cdot \Omega}{k} + \frac{1}{c}}$$

Finally, the impedance of the whole system is:

$$Z_w = \frac{1}{\frac{i \cdot \Omega}{k} + \frac{1}{c}} + i \cdot \Omega \cdot m$$

3. Chain system

Now we simulate our problem with more than one spring and mass. We cut the system in single springs with masses between them. The used model is called chain system:

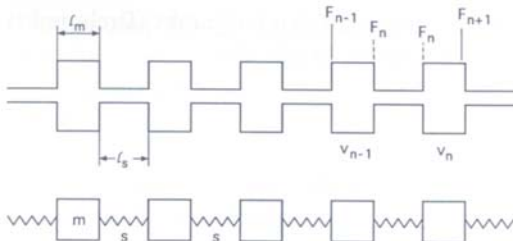

This system is used in aerodynamic calculations of ribs in aeroplanes. In the field of civil engineering it is used for rip-plates.

Picture 6: Chain system [3]

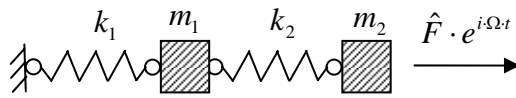

Impedance of the whole system:

$$Z = \frac{1}{\frac{i \cdot \Omega}{k} + i \cdot m_2 \cdot \Omega}$$

first spring mass system

3.1 Chain system calculated with Maple

1. Example

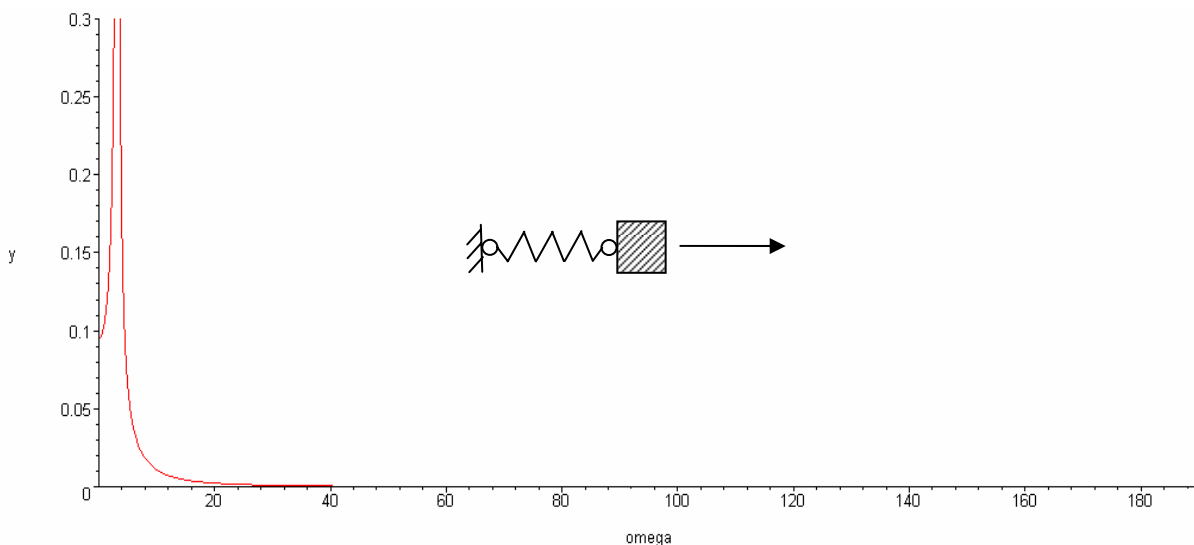

In this diagram you can see that there is one natural frequency. Now we divide the mass in several masses and cut the spring in several pieces. By this, we simulate or approximate a spring with mass.

2. Example

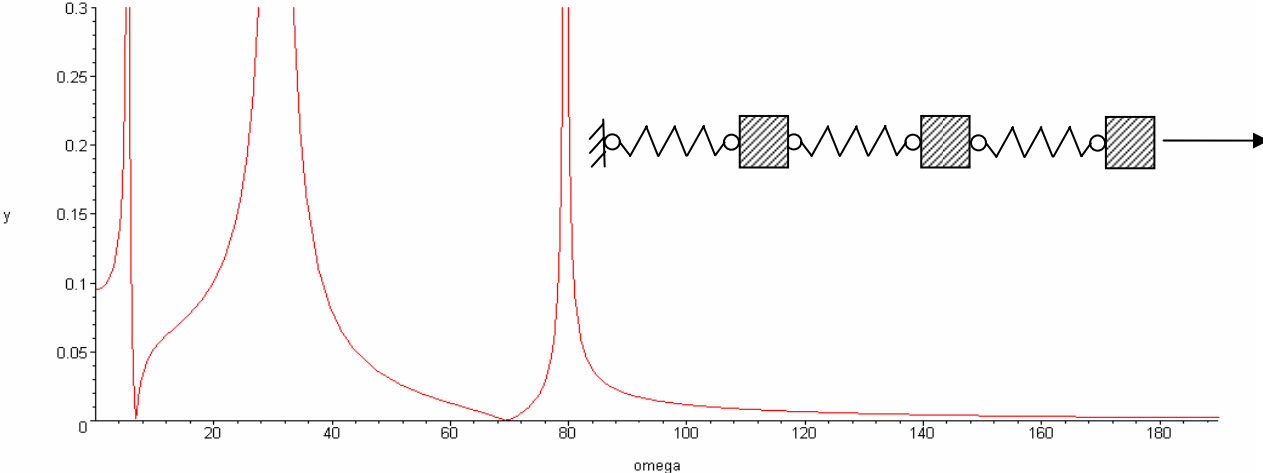

The sum of the masses of the spring is equal in each case. The stiffness is defined by $\frac{1}{k} = \sum \frac{1}{k_i}$ and the behaviour of the system remains the same. Now we can see that with every partition of the mass we get a different natural frequency. We calculate the 3rd Example to show that the lower resonance frequencies do not change.

3. Example

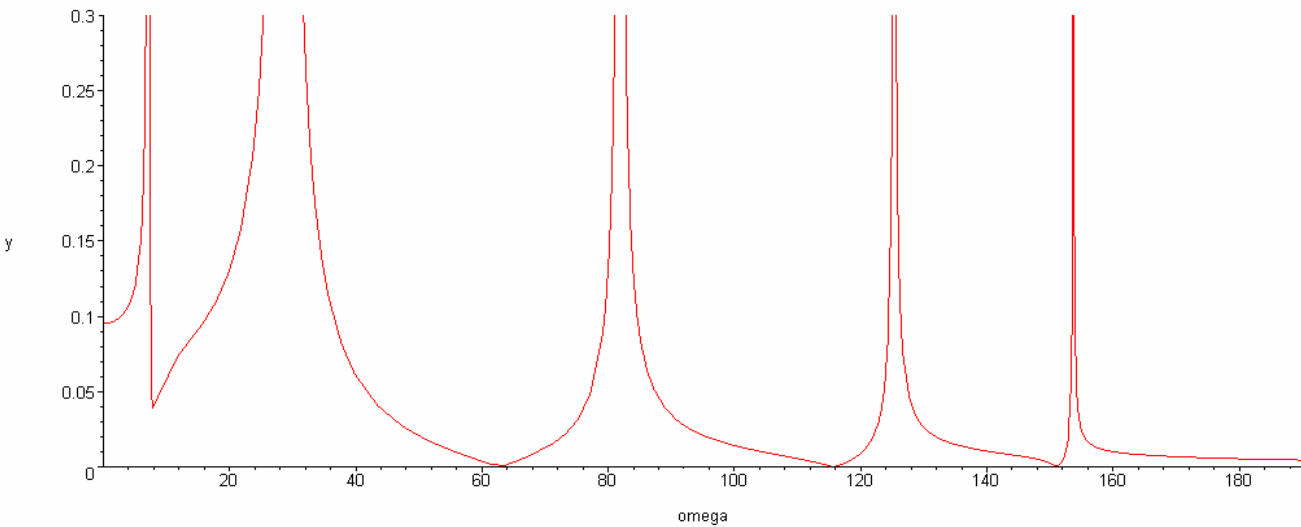
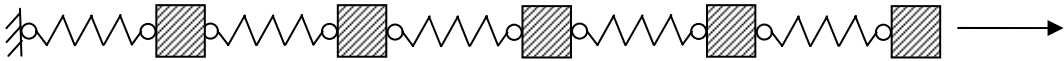

Here you can see that we obtain always resonance frequencies at higher frequencies when we consider the mass of the spring. This effect is not mentioned in the diagram of our literature research.

4.1 Longitudinal waves

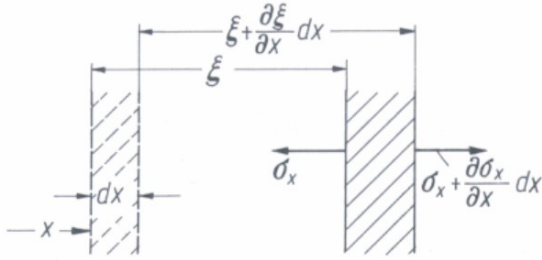

In solids as in liquids and gases, there can also occur pure longitudinal waves. Longitudinal waves are waves whose direction of particle displacement coincides with the direction of wave propagation.

Picture 7: Displacement deformations and stresses in longitudinal wave motion [3]

$$\left. \begin{array}{l} \text{strain: } \varepsilon_x = \frac{\partial \xi}{\partial x} \\ \text{stress: } \sigma_x = D \cdot \varepsilon_x \text{ (Hooke's law)} \end{array} \right\} \sigma_x = D \cdot \frac{\partial \xi}{\partial x} \quad (1)$$

The stress is not constant, but depends on the location. A net unbalanced stress acts on the mass element. This stress causes the element to accelerate. ρ represents the material density. Therefore the equation of motion is:

$$\left(\sigma_x + \frac{\partial \sigma_x}{\partial x} \cdot dx \right) - \sigma_x = \rho \cdot dx \cdot \frac{\partial^2 \xi}{\partial t^2} \Rightarrow \frac{\partial \sigma_x}{\partial x} = \rho \cdot \frac{\partial^2 \xi}{\partial t^2} \quad (2)$$

$$\text{velocity: } v_x = \frac{\partial \xi}{\partial t} \Rightarrow \frac{\partial \sigma_x}{\partial x} = \rho \cdot \frac{\partial v}{\partial t} \quad (2a)$$

Differentiation of (2a) with respect to time:

$$\frac{\partial \sigma_x}{\partial x \cdot \partial t} = \rho \cdot \frac{\partial^2 v}{\partial t^2} \quad (2b)$$

Differentiation of (1) with respect to time:

$$\frac{\partial \sigma_x}{\partial t} = D \cdot \frac{\partial \xi}{\partial x \cdot \partial t} \Rightarrow \frac{\partial \sigma_x}{\partial t} = D \cdot \frac{\partial v}{\partial x} \quad (1a)$$

Differentiation of (1a) with respect to displacement:

$$\frac{\partial \sigma_x}{\partial x \cdot \partial t} = D \cdot \frac{\partial^2 v}{\partial^2 x} \quad (1b)$$

Finally we get the wave equation by equating (1b) and (2b):

$$D \cdot \frac{\partial^2 v}{\partial^2 x} = \rho \cdot \frac{\partial^2 v}{\partial t^2}$$

Solving the wave equation we can obtain the propagate velocity c_l of the disturbance:

$$c_l = \sqrt{\frac{D}{\rho}}$$

The ratio ω/c_l is usually called wavenumber and is generally represented by an additional symbol:

$$k_L = \frac{\omega}{c_L}$$

4.2 Quasi-longitudinal waves

Pure longitudinal waves occur only in mediums whose dimensions are in all directions much greater than a wavelength. In our buildings the most acting waves are quasi-longitudinal, for example in plates, beams or shells.

In beams there is a contraction of the cross section in addition to the axial extension caused by a force in the axial direction.

$$\varepsilon_y = \varepsilon_z = -\mu \cdot \varepsilon_x$$

$\varepsilon_{x,y,z}$... Extension in the various directions

μ ... Poisson ratio

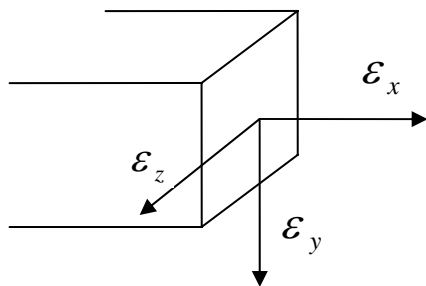

For example steel: $\mu = 0.25 - 0.30$
(Maximum of poisson ratio $\mu = 0.50$)

Picture 8: Coordinate system in a beam

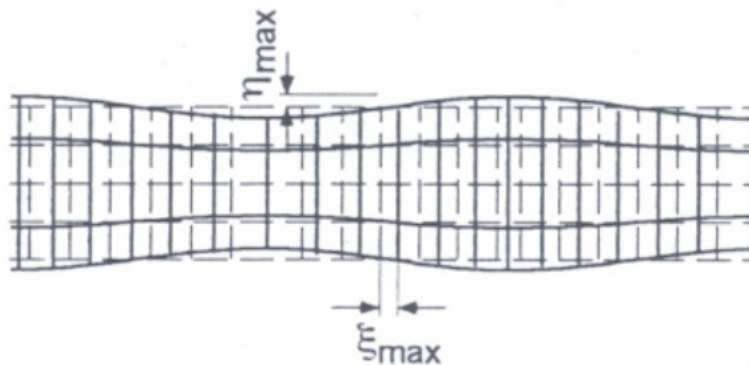

Picture 9: Deformation associated with a quasi-longitudinal wave [2]

The ratio of the greatest lateral to the greatest longitudinal displacement is about the same to the ratio of the thickness to the wavelength:

$$\frac{\hat{\eta}}{\hat{\varepsilon}} = \underbrace{\pi \cdot \mu}_{\approx 1} \cdot \frac{d}{\lambda}$$

$\hat{\eta}$... Greatest lateral displacement

$\hat{\varepsilon}$... Greatest longitudinal displacement

d ... Thickness of the constructional element

λ ... Wavelength

$$E \cdot \varepsilon_x = \sigma_x - \mu \cdot (\sigma_y + \sigma_z) \quad (1)$$

$$E \cdot \varepsilon_y = \sigma_y - \mu \cdot (\sigma_x + \sigma_z) \quad (2)$$

$$E \cdot \varepsilon_z = \sigma_z - \mu \cdot (\sigma_x + \sigma_y) \quad (3)$$

In case that there is no cross-sectional contraction permitted, namely for:

$$\varepsilon_y = \varepsilon_z = 0$$

By adding the equation (2) to (3), we obtain:

$$\sigma_y + \sigma_z = \frac{2 \cdot \mu}{1 - \mu} \cdot \sigma_x$$

After this we have to substitute the first equation:

$$E \cdot \varepsilon_x = \sigma_x \cdot \left(1 - \frac{2 \cdot \mu^2}{1 - \mu}\right)$$

Finally, if we use $\sigma = D \cdot \varepsilon_x$, we get the longitudinal stiffness D:

$$D = \frac{E}{1 - 2 \cdot \mu^2 / (1 - \mu)} = \frac{E \cdot (1 - \mu)}{(1 + \mu) \cdot (1 - 2 \cdot \mu)}$$

4.3 Impedance of a beam wave guide

In L. Cremer, M. Heckl „**Körperschall - Physikalische Grundlagen und technische Anwendungen**“ we find the following solution for this wave equation, corresponding with our system:

$$v_1 = v_0 \cdot \cos(\bar{k} \cdot l_s) - i \cdot \frac{F_0}{\bar{Z}} \cdot \sin(\bar{k} \cdot l_s)$$

$$F_1 = -i \cdot \bar{Z} \cdot \sin(\bar{k} \cdot l_s) + F_0 \cdot \cos(\bar{k} \cdot l_s)$$

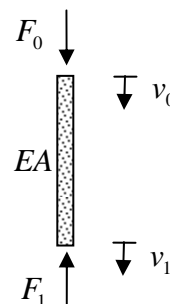

Converted the equations into a matrix form:

$$\begin{bmatrix} -\bar{Z} \cdot \frac{\cos(\bar{k} \cdot l_s)}{\sin(\bar{k} \cdot l_s)} & \frac{\bar{Z}}{\sin(\bar{k} \cdot l_s)} \\ -\frac{\bar{Z}}{\sin(\bar{k} \cdot l_s)} & \bar{Z} \cdot \frac{\cos(\bar{k} \cdot l_s)}{\sin(\bar{k} \cdot l_s)} \end{bmatrix} \cdot \begin{bmatrix} v_0 \\ v_1 \end{bmatrix} = \begin{bmatrix} F_0 \\ F_1 \end{bmatrix}$$

$$\bar{Z} = Z_{LII} = \sqrt{E \cdot \rho} \cdot S$$

$$\bar{k} = \frac{\Omega}{c_{LII}} = \frac{\Omega}{\sqrt{E/\rho}}$$

4.4 Examples

1. Example

Now we consider the following case by using the wave equation.
The spring is replaced by a longitudinal wave element.

For the first example we put the beam on a fix foundation ($Z_u = 0$).

$$\begin{bmatrix} -\bar{Z} \cdot \frac{\cos(\bar{k} \cdot l_s)}{\sin(\bar{k} \cdot l_s)} + m \cdot \Omega & \frac{\bar{Z}}{\sin(\bar{k} \cdot l_s)} \\ -\frac{\bar{Z}}{\sin(\bar{k} \cdot l_s)} & \bar{Z} \cdot \frac{\cos(\bar{k} \cdot l_s)}{\sin(\bar{k} \cdot l_s)} + Z_u \end{bmatrix} \cdot \begin{bmatrix} v_0 \\ v_1 \end{bmatrix} = \begin{bmatrix} F_0 \\ F_1 \end{bmatrix}$$

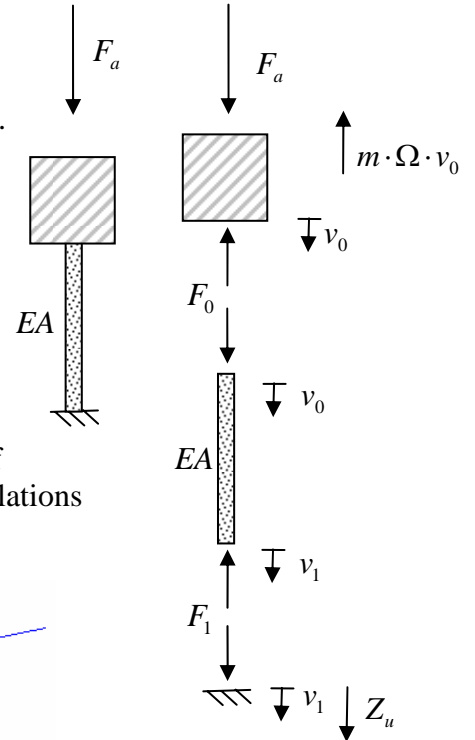

We can prove with the following print of Maple that the diagram of L.Cremer and M.Möser “Technische Akustik” is equal to our calculations if we consider only a low frequency band:

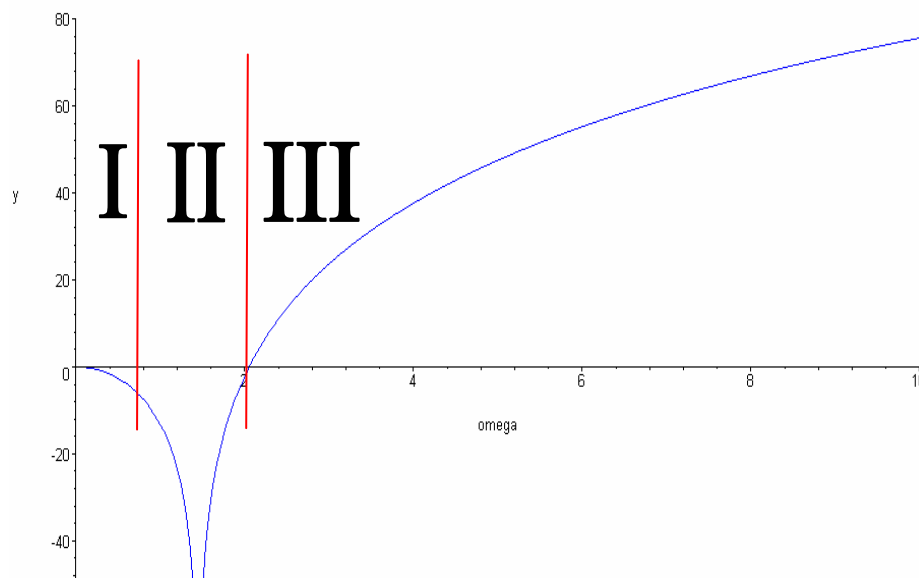

But if we have a look at higher frequencies, we obtain many singularities shown in the next diagram:

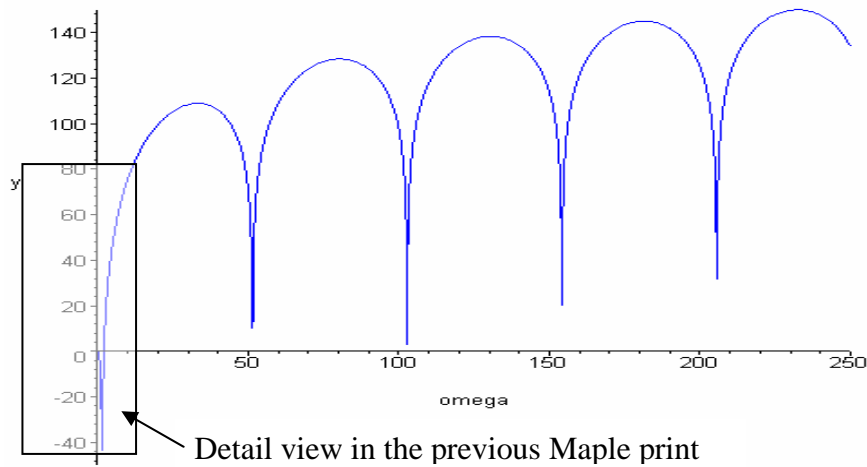

We can also find measurements of steel and rubber springs (elastic mounts) which correspond with our calculation:

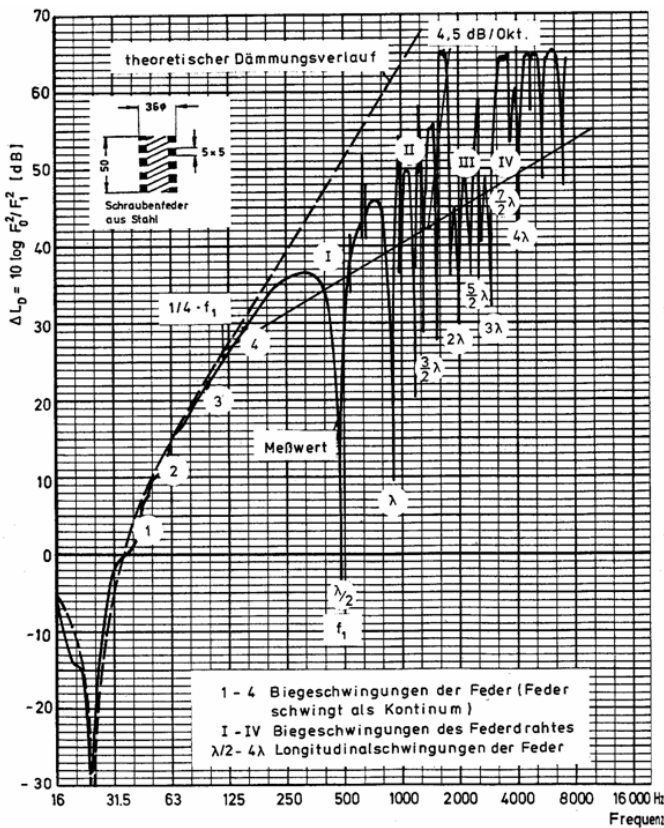

Picture 10: measurements of steel spring [6]

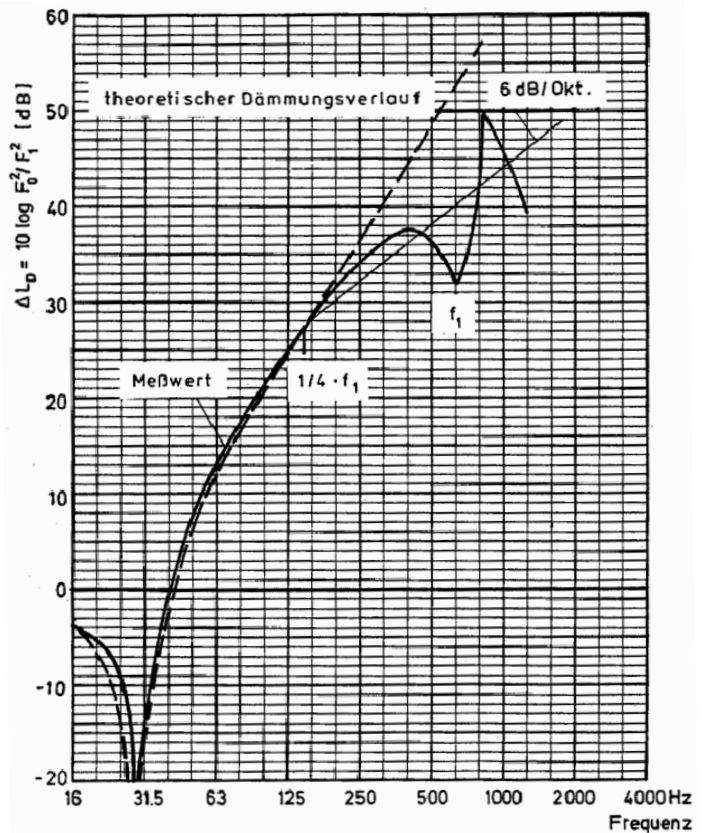

Picture 11: measurements of rubber element [6]

2. Example:

In our 2nd example we consider the same system supported on a plate with contact impedance. For this calculation we use the following table:

		Z	$\text{Re}\{A\}$	$\text{Im}\{A\}$	V_q
Stab		$\rho c_L S$	$\frac{1}{\rho c_L S}$	0	$\frac{1}{2\pi} S \lambda_L$
Balken, dünn		$2m' c_B (1+j)$	$\frac{1}{4m' c_B}$	$\frac{-1}{4m' c_B}$	$\frac{4}{2\pi} S \lambda_B$
Balken, dünn		$\frac{m' c_B}{2} (1+j)$	$\frac{1}{m' c_B}$	$\frac{-1}{m' c_B}$	$\frac{1}{2\pi} S \lambda_B$
Balken (Timoshenko)		(4.94)	(4.94)	(4.94)	-
Membran		(4.97) für $B' \rightarrow 0$	$\frac{1}{4} \frac{\omega}{T'}$	∞	$\frac{1}{\pi^2} h \lambda^2$
Platte, dünn		$8\sqrt{B' m''}$	$\frac{1}{8\sqrt{B' m''}}$	0	$\frac{2}{\pi^2} h \lambda_B^2$
Platte, dünn		$3.5\sqrt{B' m''}$	$\frac{1}{3.5\sqrt{B' m''}}$	0	$\frac{0.9}{\pi^2} h \lambda_B^2$
Platte, Schubsteife		(4.62)	(4.62a)	(4.62a)	-
Platte, tang.		-	$\approx 2\omega/Eh$	-	$\frac{1}{3\pi^2} h \lambda_T^2$
Platte, orthotrop		(4.67)	(4.67)	0	-

We select a thin plate:

$$\bar{Z}_u = 8 \cdot \sqrt{B' \cdot m''}$$

We choose a plate of concrete with a thickness of 30 cm:

$$B' = \frac{E}{1-\mu^2} \cdot \frac{h^3}{12} = \frac{30.000 \cdot 10^6}{1-0,3^2} \cdot \frac{0,30^3}{12} =$$

$$B' = 7,42 \cdot 10^7$$

$$m'' = 2500 \cdot 0,30 = 750 \text{ kg} / \text{m}^2$$

$$Z_u = 1,89 \cdot 10^6$$

Table 1: Contact impedance of various systems [3]

In the following print we can see the effect of the impedance of the plate.

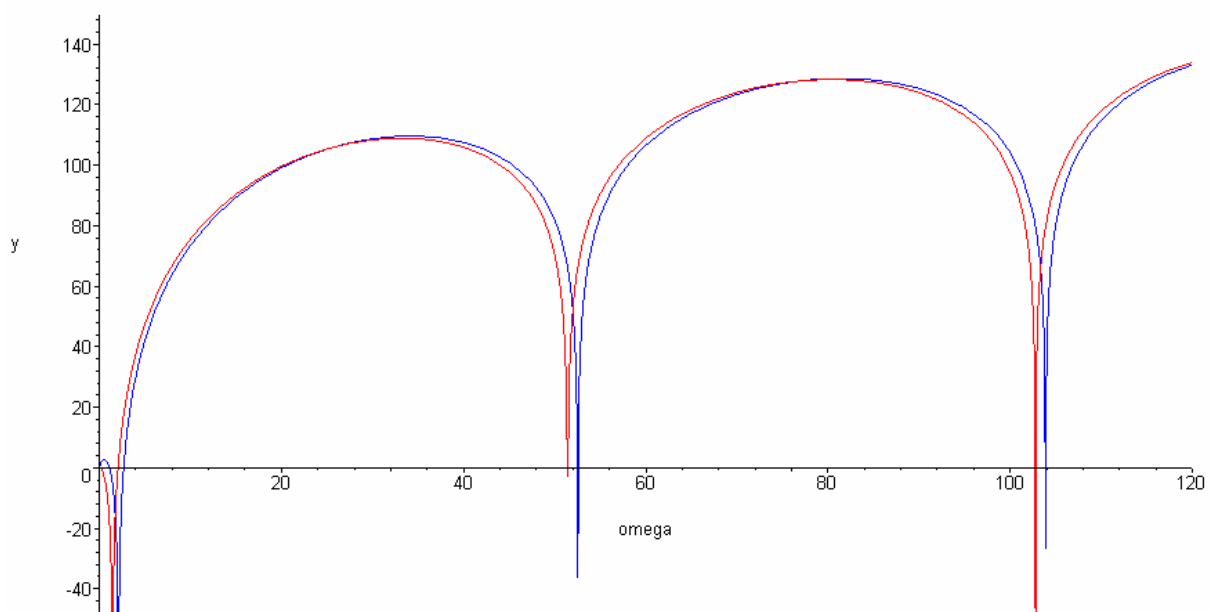

5. Two degree of freedom system

Finally we show another way to calculate a type of chain system where we can calculate the velocity and force of every part of the system. That information's get lost if we use an impedance chain model.

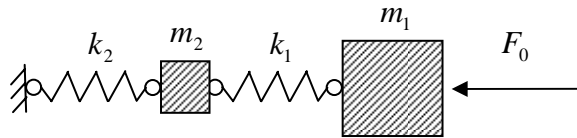

$$\begin{bmatrix} m_1 & 0 \\ 0 & m_2 \end{bmatrix} \cdot \begin{bmatrix} \ddot{w}_1 \\ \ddot{w}_2 \end{bmatrix} + \begin{bmatrix} k_1 & -k_1 \\ -k_1 & k_2 + k_1 \end{bmatrix} \cdot \begin{bmatrix} w_1 \\ w_2 \end{bmatrix} = \begin{bmatrix} F \\ 0 \end{bmatrix}$$

Using the following equation $\ddot{w} = -\Omega^2 \cdot w$, we can simplify the matrix into:

$$\begin{bmatrix} k_1 - m_1 \cdot \Omega^2 & -k_1 \\ -k_1 & k_2 + k_1 - m_2 \cdot \Omega^2 \end{bmatrix} \cdot \begin{bmatrix} w_1 \\ w_2 \end{bmatrix} = \begin{bmatrix} F \\ 0 \end{bmatrix}$$

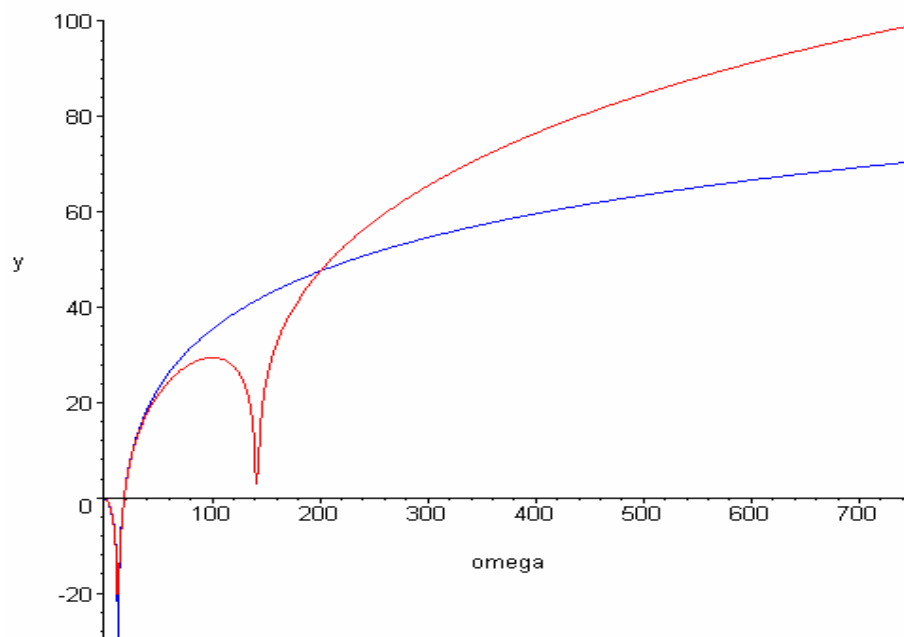

In this Maple sheet we can see two effects of using a double mass elastic mount: First of all you get a second resonance frequency, but after passing the second resonance frequency we observe a better damping effect. The gradient of the red graph is about the double of the blue one.

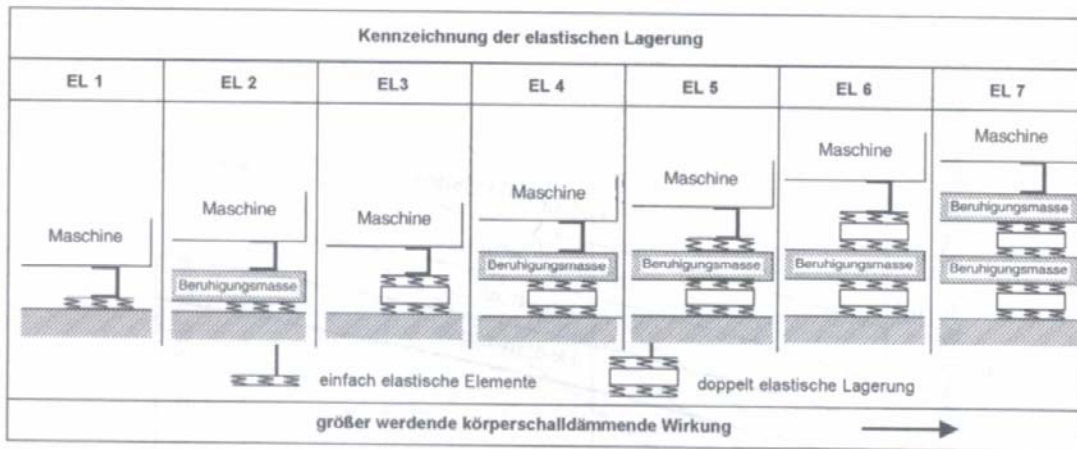

Picture 12: Elastic mount systems [5]

From picture 12 we can obtain the optimal elastic mount for each vibrating system. In this kind of table we can see that multi mass systems are very useful but the construction becomes more difficult and expensive.

6. Conclusion

We verified the diagram of elastic mounts and we found out that at higher frequencies, we have to change the mechanic of the model, because there are effects that follow if the mass of the spring is regarded.

If we do not consider this mass in case we have a high frequency problem, we may obtain a bad effect, which is not shown in the diagram. Using the chain system we get a good approximation of this problem, but the exact solution can only be obtained by solving the differential equation of a longitudinal wave system. Another important point for these calculations is the contact impedance, because supports can rarely be treated as a fix support. In this case we get other solutions.

We wanted to show that it is essential to check the boundary conditions of your dynamic problem before choosing your mechanic model. The literature gives a lot of solutions, but you always have to consider the limits of each calculation system.

References

- [1] G. Müller. **Lecture manuscript Structural Dynamics**. Lehrstuhl für Baumechanik. October 2005
- [2] L. Cremer, M. Möser „**Technische Akustik**“
6. Auflage, 2005, Springer Verlag , Berlin
- [3] L. Cremer, M. Heckl „**Körperschall - Physikalische Grundlagen und technische Anwendungen**“, 2.Auflage, 1996, Springer Verlag, Berlin
- [4] H. Grundmann, M. Knittel, „**Einführung in die Baumechanik**“, Heft 9, 1983, München
- [5] G. Müller, M. Möser „**Taschenbuch der Technischen Akustik**“, 3. Auflage, Springer Verlag, 2004, Berlin
- [6] Dr.-Ing. Johannes Guggenberger (Müller-BBM) „Körperschallisolierung von haustechnischen Geräten“
DAGA 2006, Braunschweig