

**MEMS  
and  
Nanotechnology**

1. introduction
2. definition of MEMS & NEMS
3. active principles
4. types of MEMS
5. fabrication
6. problems with the fabrication

1. introduction
2. definition of MEMS & NEMS
3. active principles
4. types of MEMS
5. fabrication
6. problems with the fabrication

## The Beginning

In Dec. 1959 Richard Feynman offered a prize of \$1,000.

Challenge: build an electrical motor, each side smaller than

$$\frac{1}{64} \text{ in} \approx 0.397 \text{ mm}$$

## electrical motor by William McLellan

diameter: 381  $\mu\text{m}$

tools used for assembly:

- microscope
- sharpened tooth pick
- hairs of a fine artist's brush

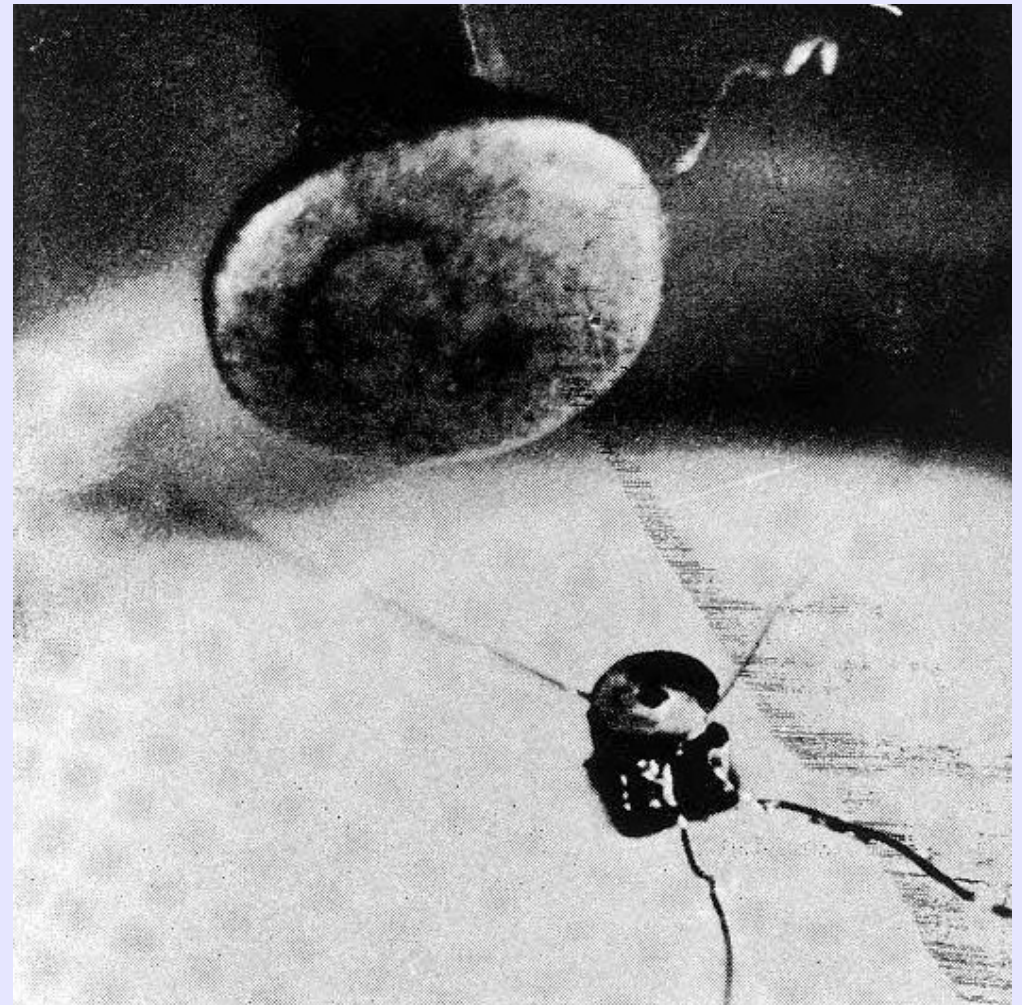

McLellan's micromotor photographed under a microscope (Caltech Institute Archives)

1. introduction
2. definition of MEMS & NEMS
  - 2.1. What is MEMS?
  - 2.2. What is NEMS?
  - 2.3. problems with NEMS
3. active principles
4. types of MEMS
5. fabrication
6. problems with the fabrication

MEMS - microelectromechanical systems

transformation of energy:

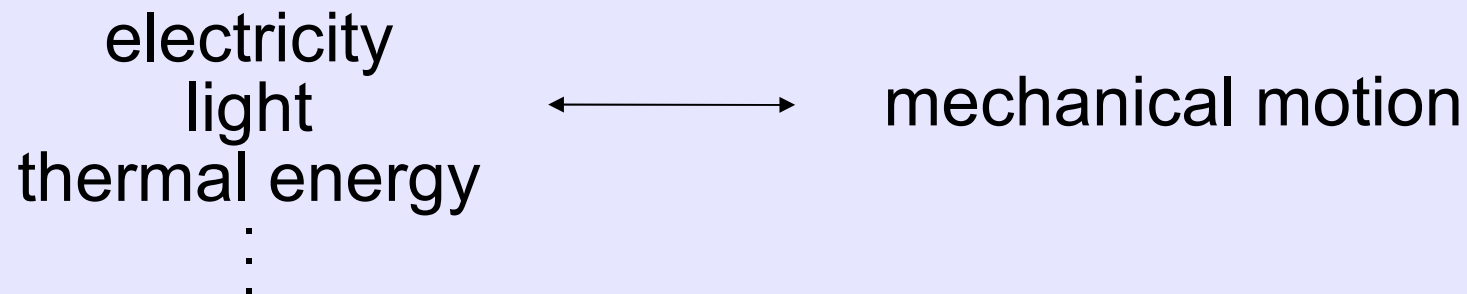

MEMS mainly move by elastic deformation of their flexible components.

# What is MEMS?

spider mite (length: approx. 0.5mm)

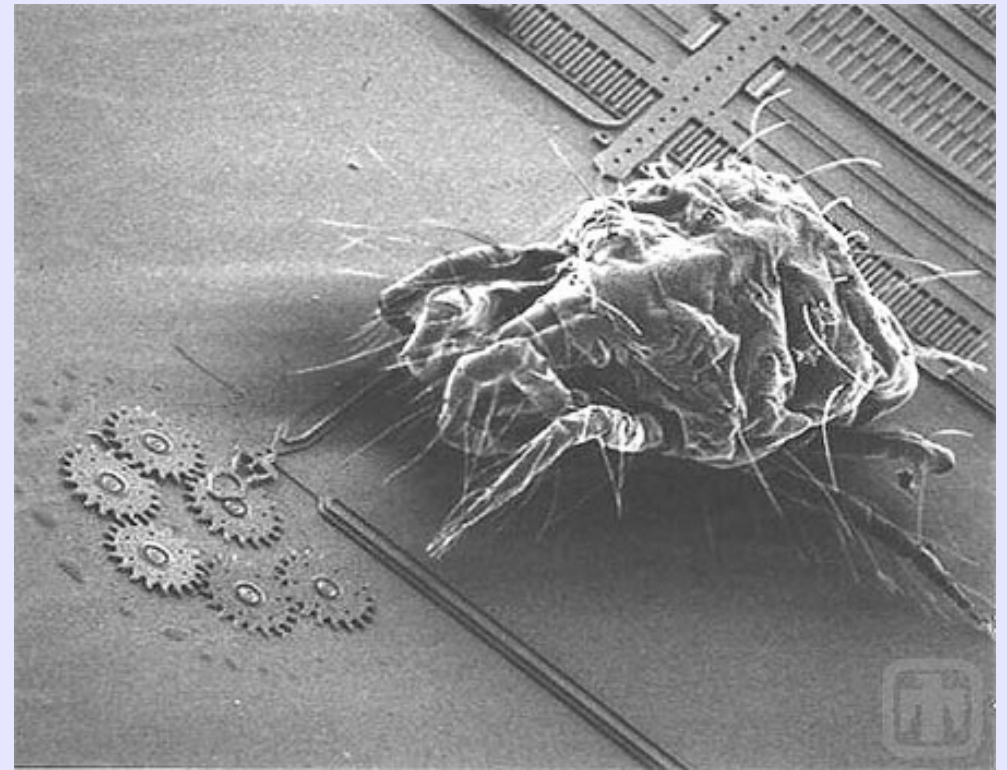
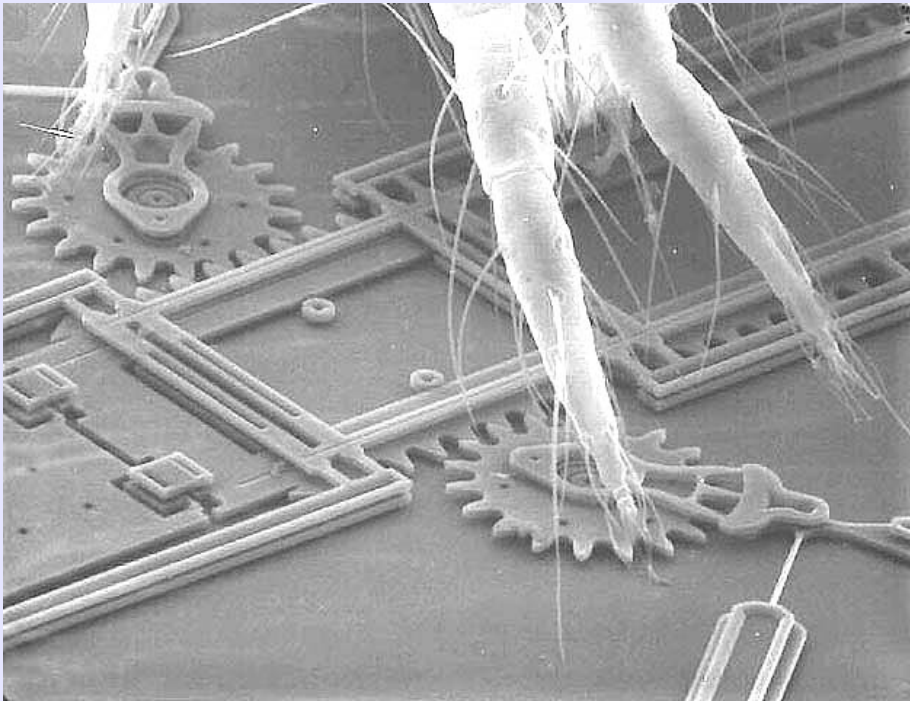

Courtesy of Sandia National Laboratories, SUMMiT™ Technologies, [www.mems.sandia.gov](http://www.mems.sandia.gov)



## NEMS - nanoelectromechanical systems

- similar to MEMS but smaller (nanoscale)
- future prospects: ability to measure small displacements and forces at a molecular scale

The border between MEMS and NEMS can hardly be defined:  
500nm or 0.5 $\mu$ m ?



# problems with NEMS-technology

It is possible to create structures with only several nanometers in size, BUT:

- nanoscale cantilevers/beams: a considerable big number of atoms are surface atoms
- interference with surrounding molecules
- additional physical effects have to be considered (e. g. increased influence of adhesion)

⇒ just scaling down MEMS layouts does not work!



# problems with NEMS-technology

## some examples:

- NEMS can respond to masses of single atoms: sensors could respond to impacts of molecules
- measurement of small deflection/forces also means small signals: difficulty to tell the signals apart from the noise
- adhesion of pieces that operate as capacitive electrodes could induce short circuits



# problems with NEMS-technology

- effects, that are irrelevant to micro devices, have to be considered for nano devices
- new design approaches have to be found
- production and packaging have to take place in an extremely clean environment

1. introduction
2. definition of MEMS & NEMS
- 3. active principles**
  - 3.1. thermal transduction
  - 3.2. electrostatic transduction
  - 3.3. piezo-resistive effect
4. types of MEMS
5. fabrication
6. problems with the fabrication

## thermal transduction

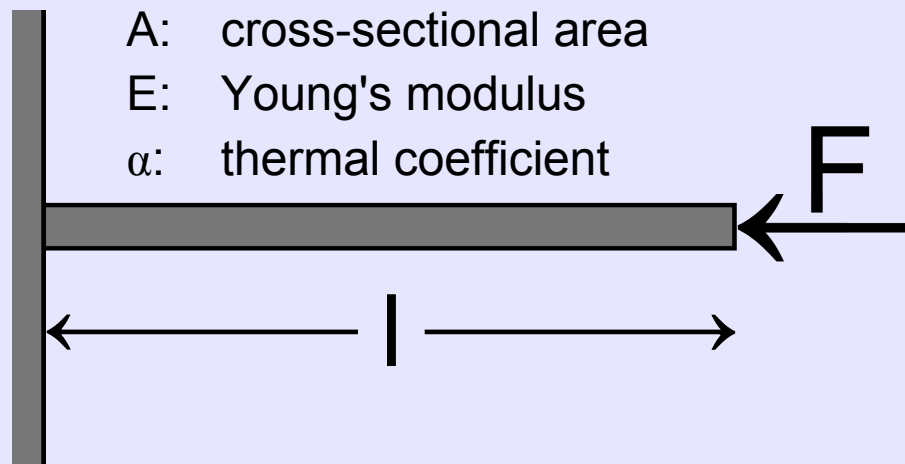

change in length:

$$\Delta l = \alpha \cdot l \cdot \Delta T$$

block force:

$$F_b = E \cdot A \cdot \alpha \cdot \Delta T$$

$$F = F_b$$

$\Rightarrow$  no displacement

## thermal transduction

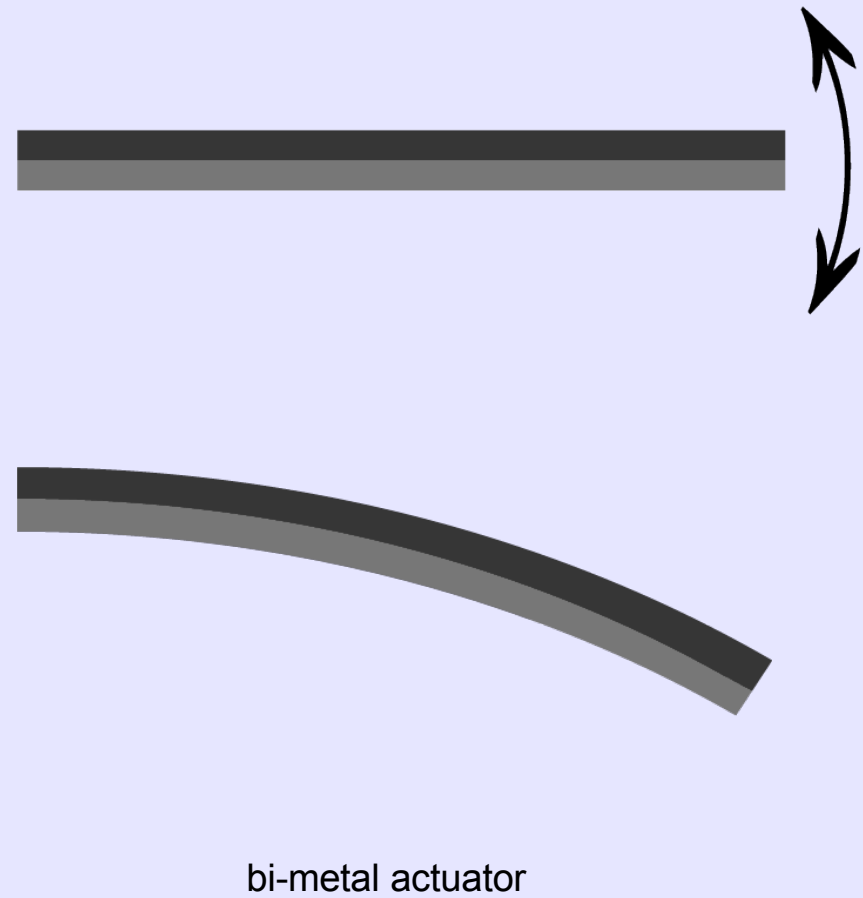
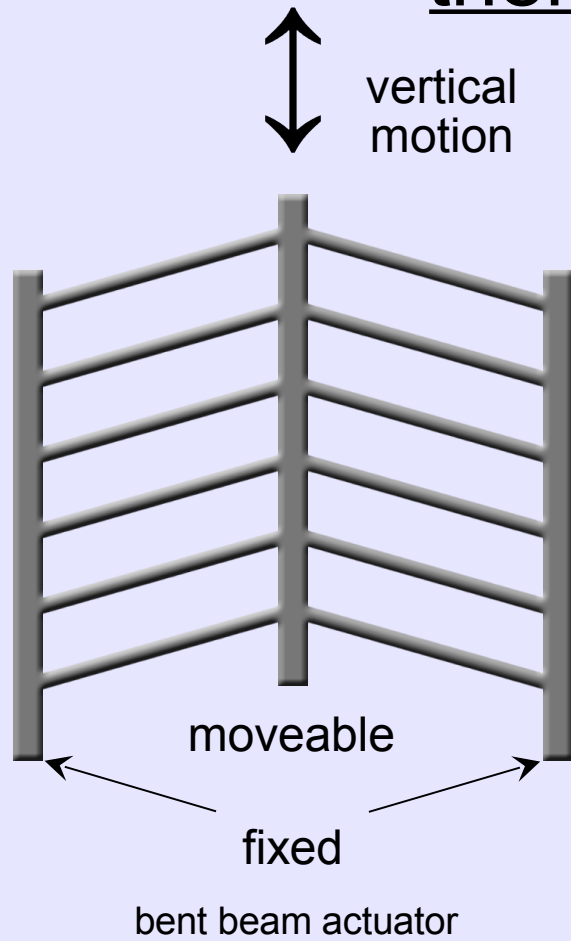

## advantages & disadvantages of thermal transduction

- + large forces/displacements
- large input energies
- low frequencies



## electrostatic transduction

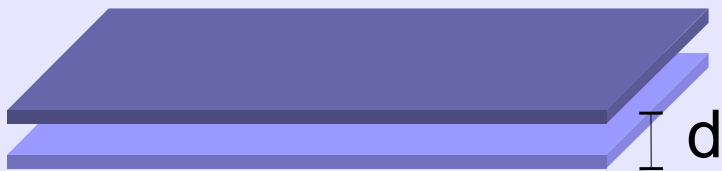

parallel plate movement:  $\Delta x$

comb finger movement:  $\Delta A$

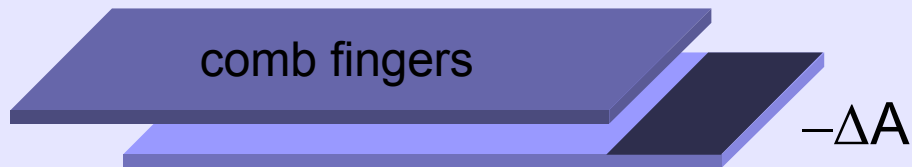

$$\Delta U = -Q \frac{x}{\epsilon \Delta A}$$



$$\Delta U = Q \frac{\Delta x}{\epsilon A}$$

## electrostatic transduction

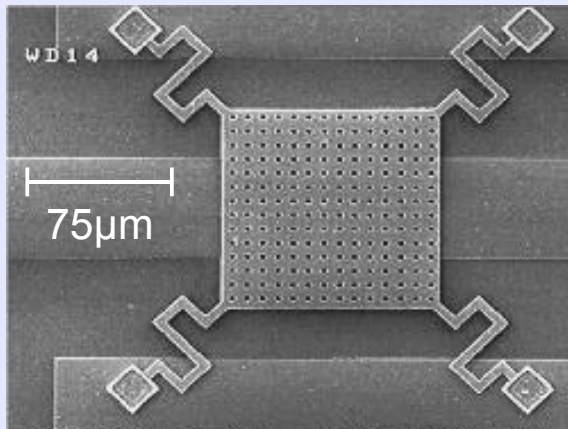

spring elements

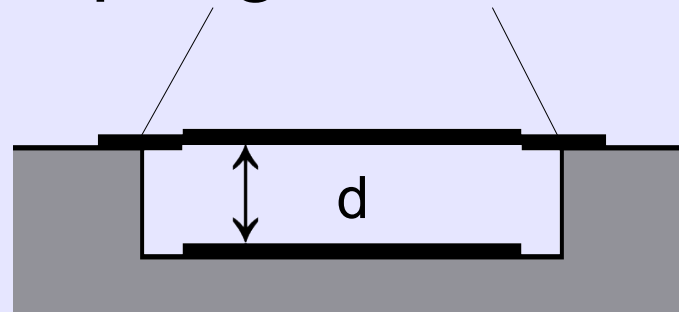

parallel electrodes

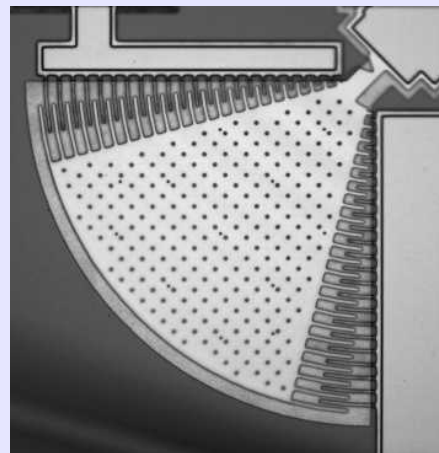
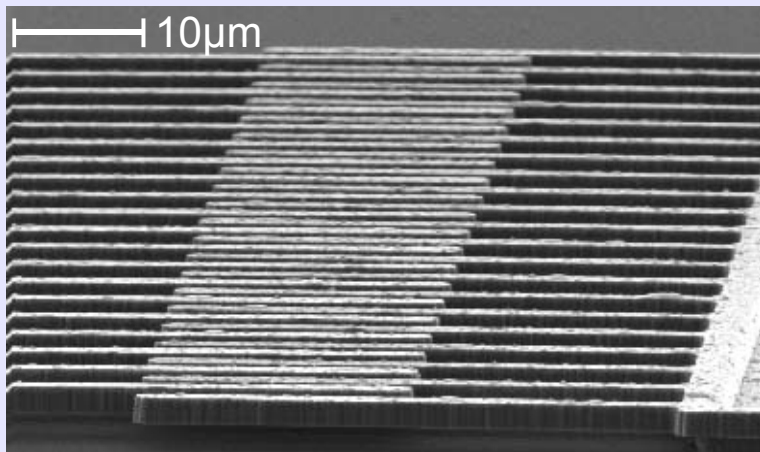

comb drives

## advantages & disadvantages of electrostatic transduction

- + fast response
- + easy integration with CMOS
- small actuation force

## piezo-resistive effect

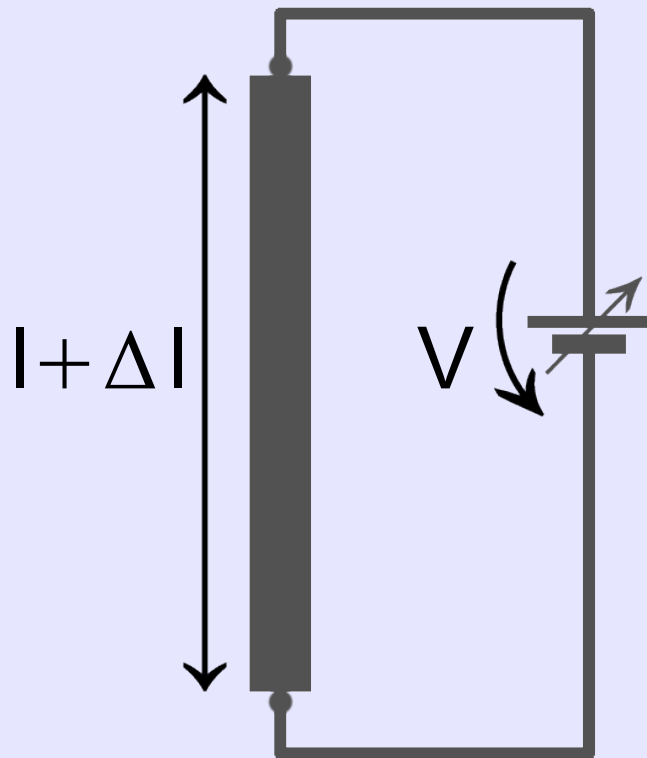

connect piezo  
actuator to voltage  
source

⇒ change in length

## piezo-resistive effect

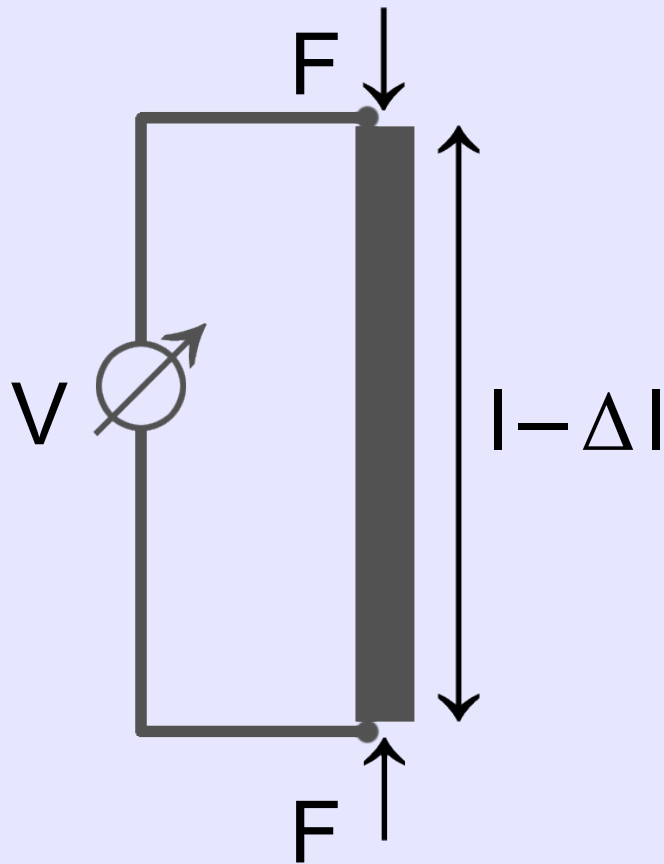

compress or expand  
piezo sensor

⇒ potential difference

## piezo-resistive effect in polysilicon

gauge factor  $K = \frac{\frac{\Delta R}{R}}{\frac{\Delta l}{l}}$

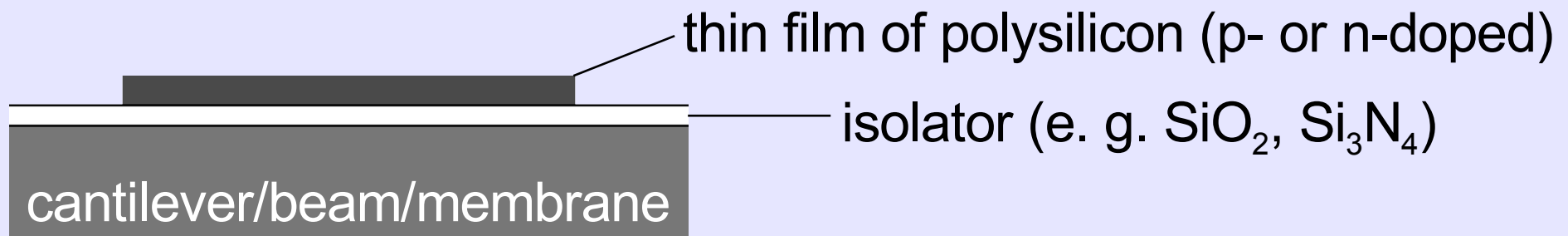

## piezo-resistive effect in polysilicon

maximum gauge factor

p-doped: – 40

n-doped: 20

$$N_{A/D} \approx 10^{19} \text{cm}^{-3}$$

$$T_{\text{CVD}} = 560^\circ\text{C}$$

annealing: 1000...1100°C

1. introduction
2. definition of MEMS & NEMS
3. active principles
- 4. types of MEMS**
  - 4.1. sensors
  - 4.2. actuators
5. fabrication
6. problems with the fabrication



- sensors
  - accelerometers
  - gyroscopes
- actuators
  - micromirrors
  - droplet generator
  - microengines
  - micropumps

## accelerometers

- in automotive applications to activate safety systems and to implement vehicle stability systems
- hard disc protection systems
- ...

## accelerometers

a simple MEMS accelerometer is designed as followed:

- the proof mass is suspended by one to four silicon beams
- basic design and mechanical equivalent:

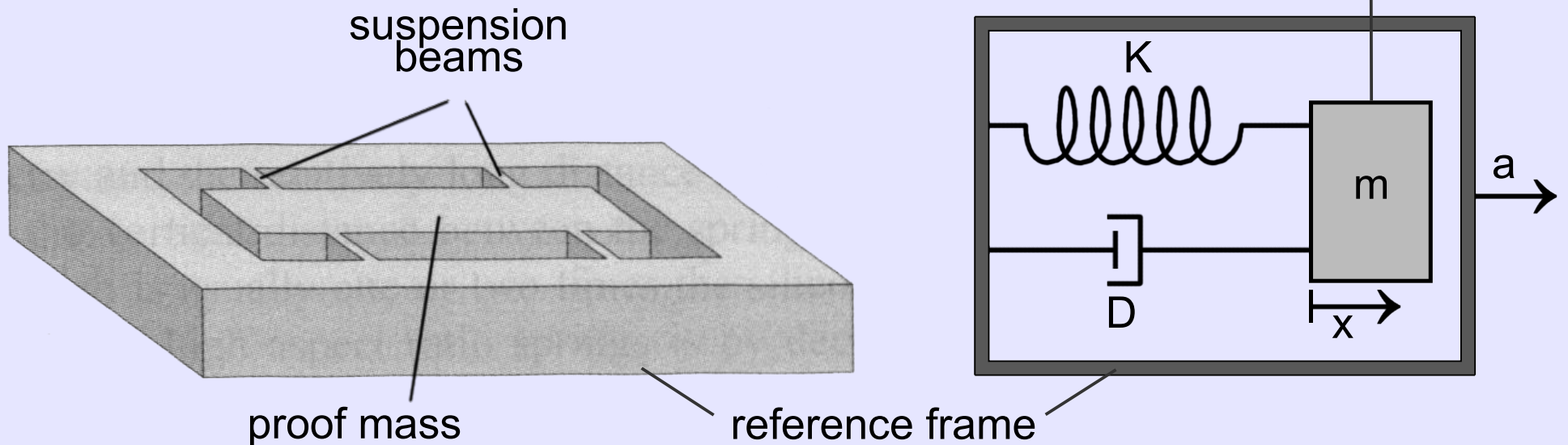

## accelerometers

- acceleration causes displacement of the proof mass
- displacement of the proof mass can be measured by strain gauges in the beams or change in capacitance

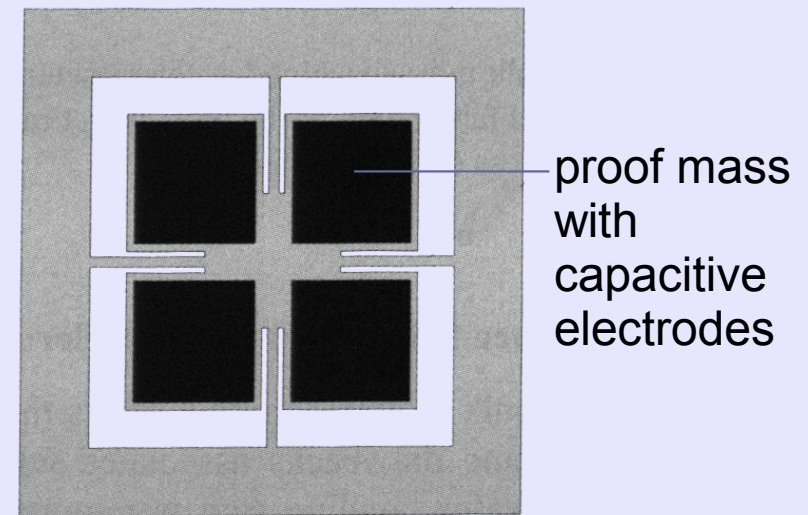
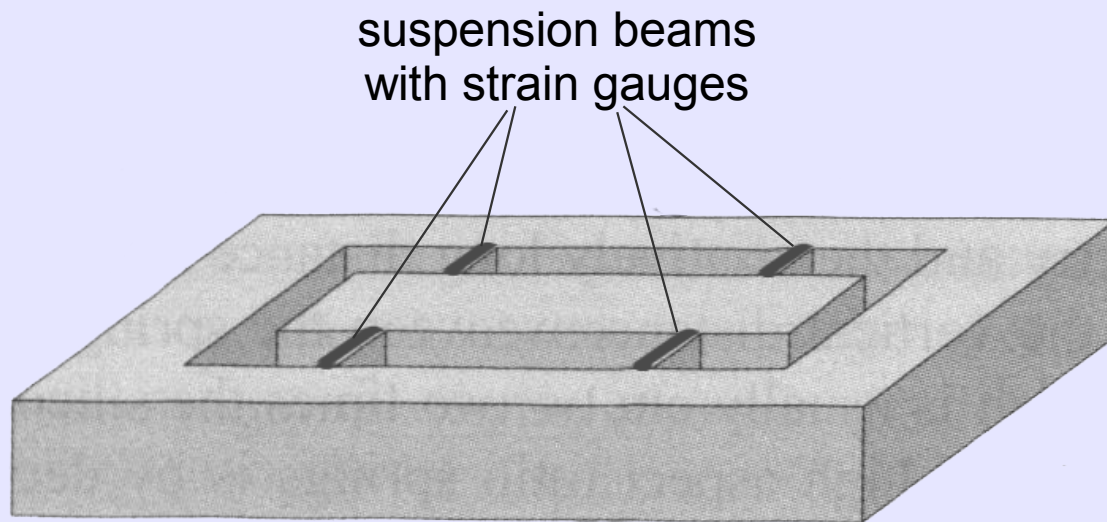

## accelerometers

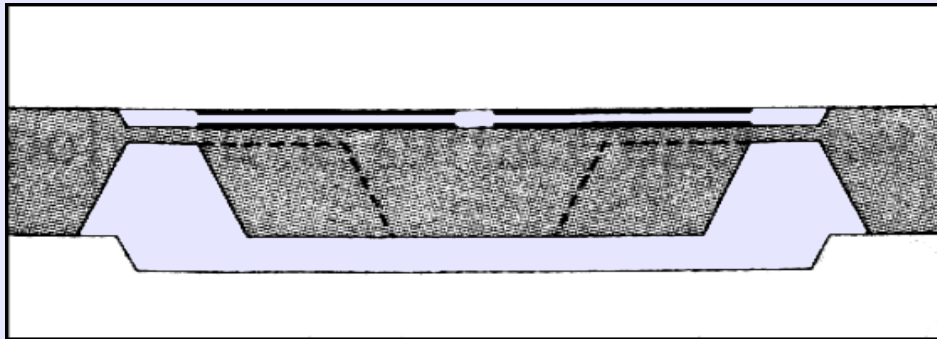

depending on the change in each capacitance, the three-dimensional acceleration vector can be derived

vertical acceleration

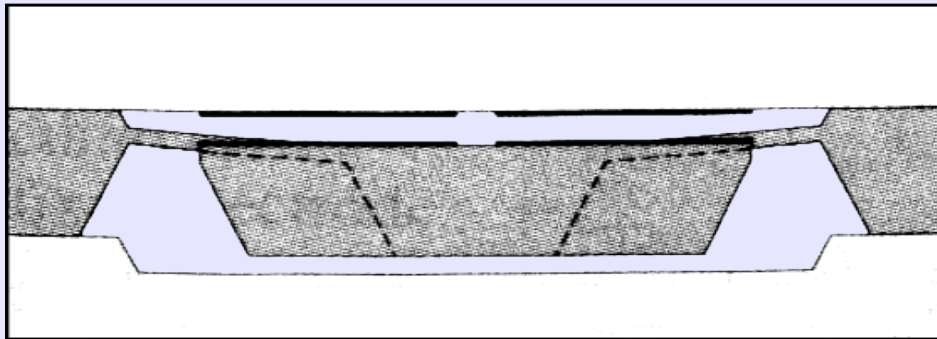

horizontal acceleration

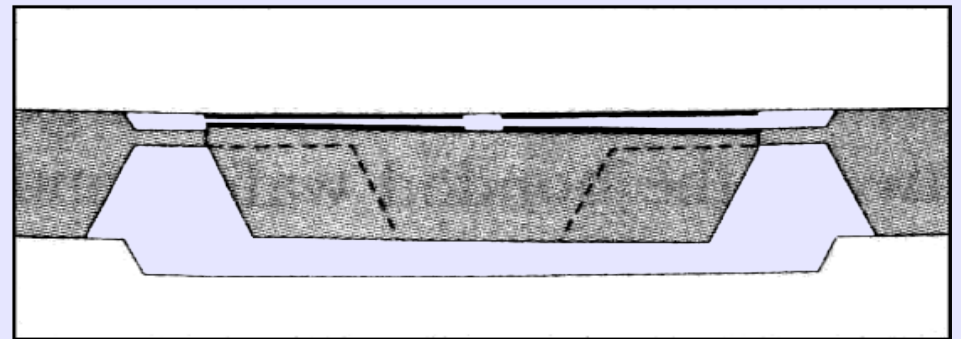

## gyroscopes

vibratory gyroscopes: transfer of energy  
between two vibration  
modes

vibrating mechanical element: proof mass

## gyroscopes

Coriolis acceleration

$$\vec{a}_c = 2 \vec{\omega} \times \vec{v}$$

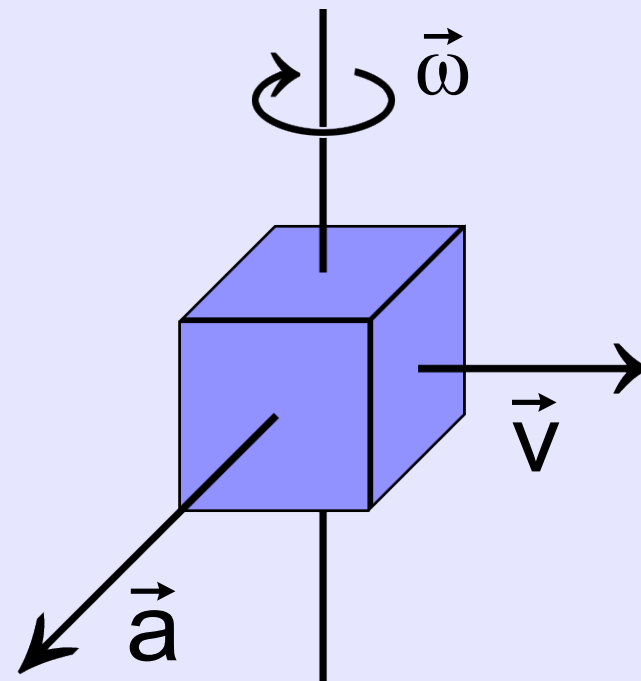

## tuning fork gyroscope

rotation detection  
by capacitive  
electrodes under  
the proof mass

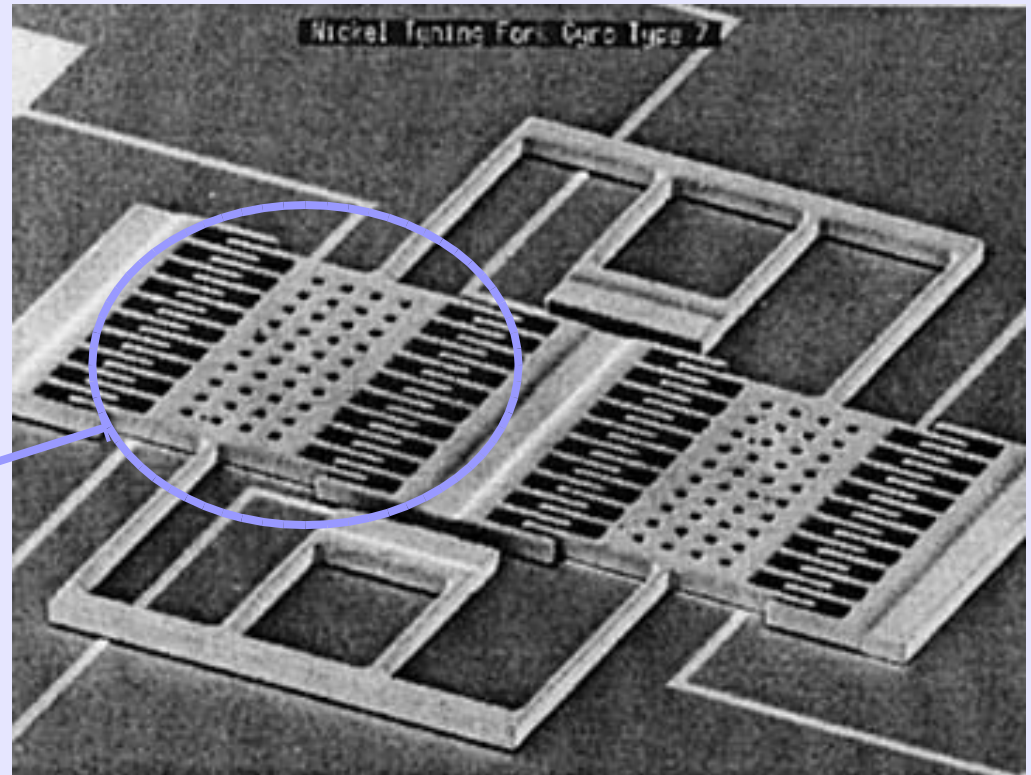
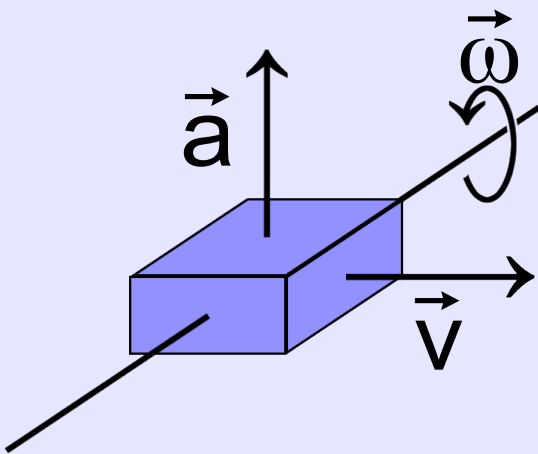

Draper Lab comb drive tuning fork gyroscope



## micromirrors for phase modulation

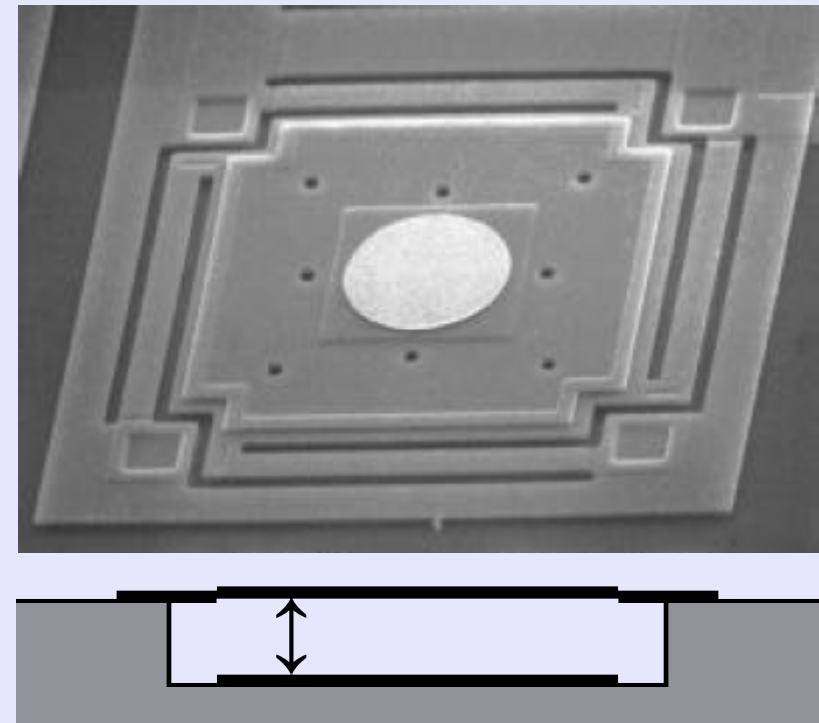
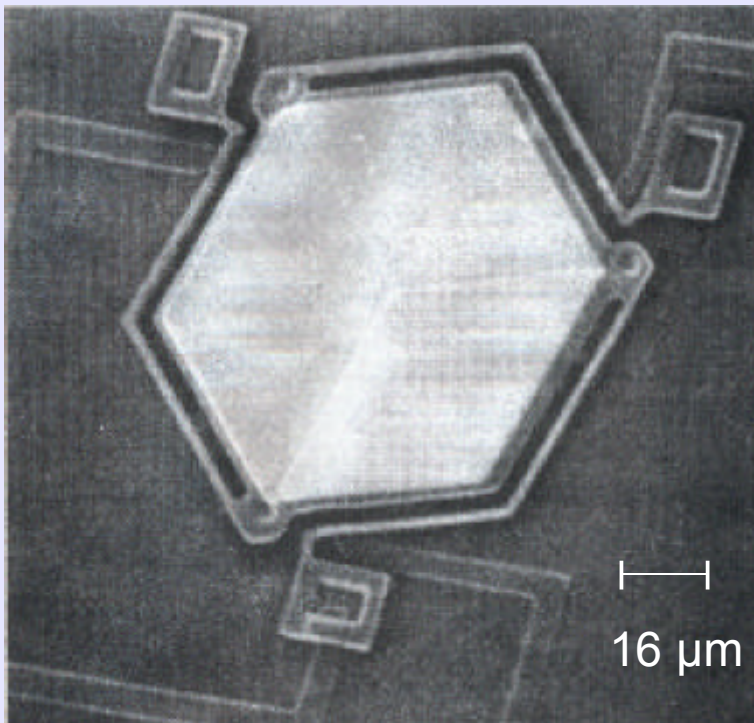

# actuators: droplet generator

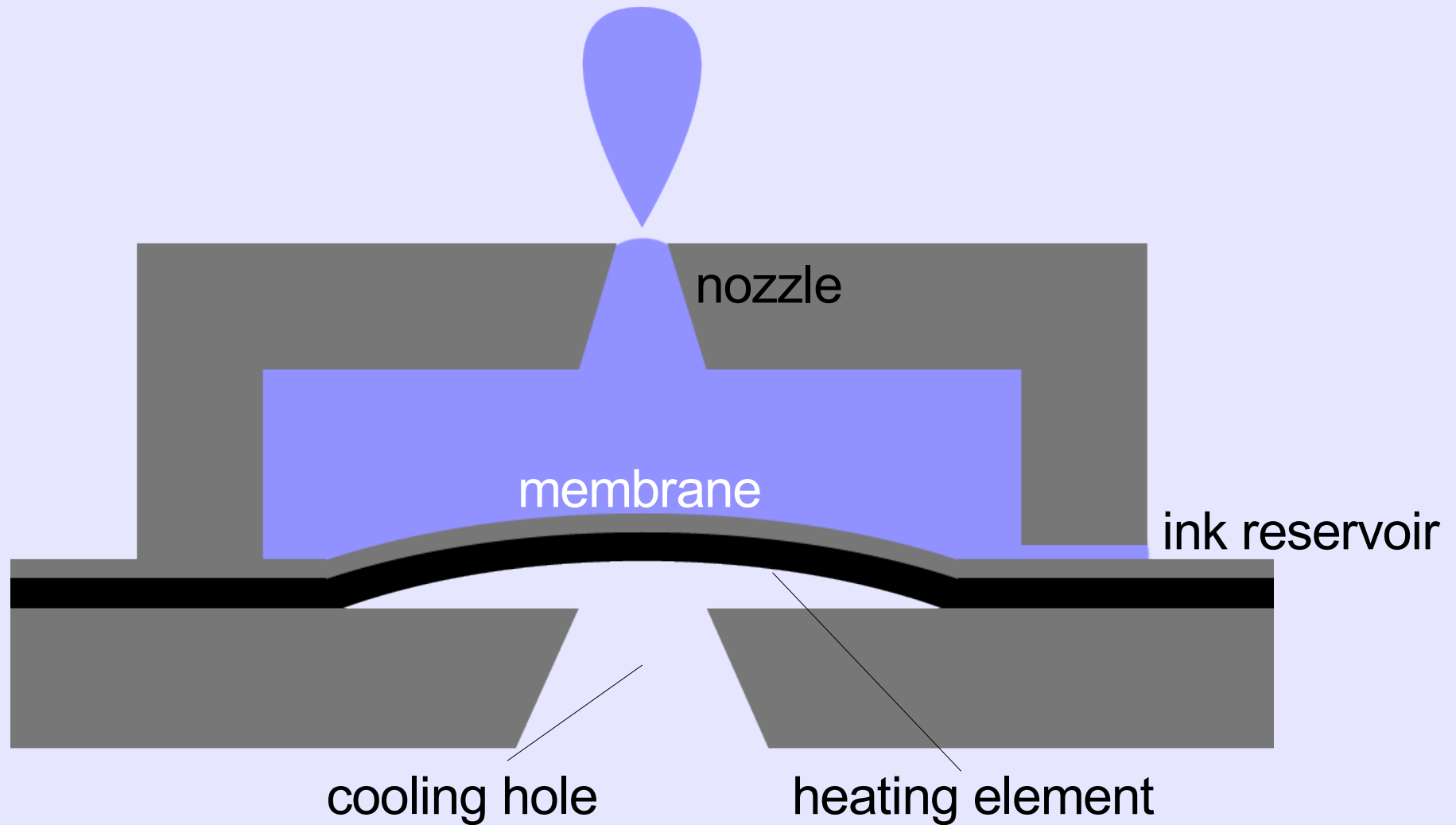

microengine with  
electrostaticly  
driven combdrives

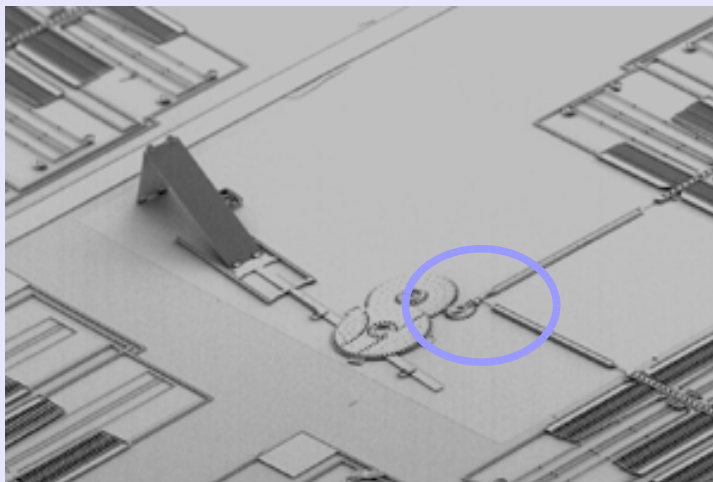
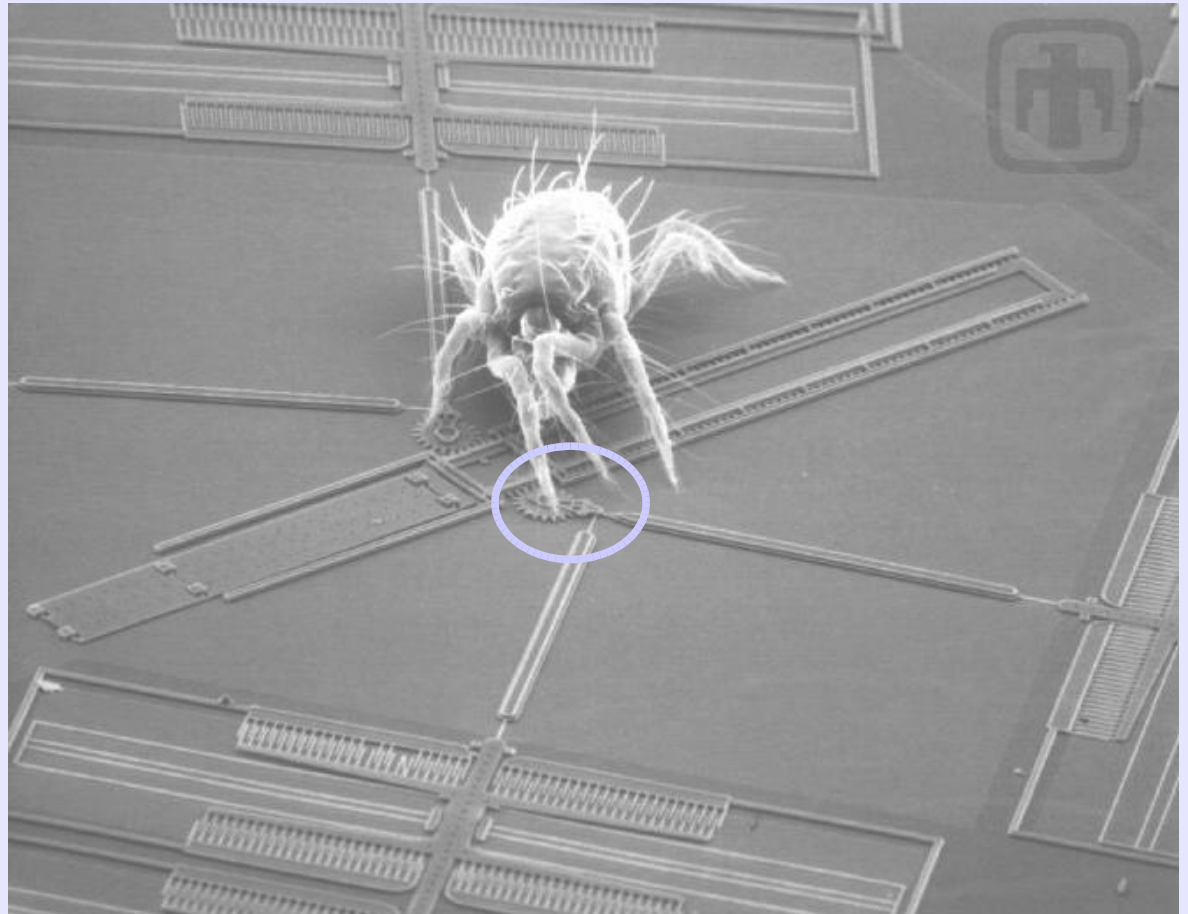

Courtesy of Sandia National Laboratories, SUMMiT™ Technologies, [www.mems.sandia.gov](http://www.mems.sandia.gov)

close-up view on different linkage designs

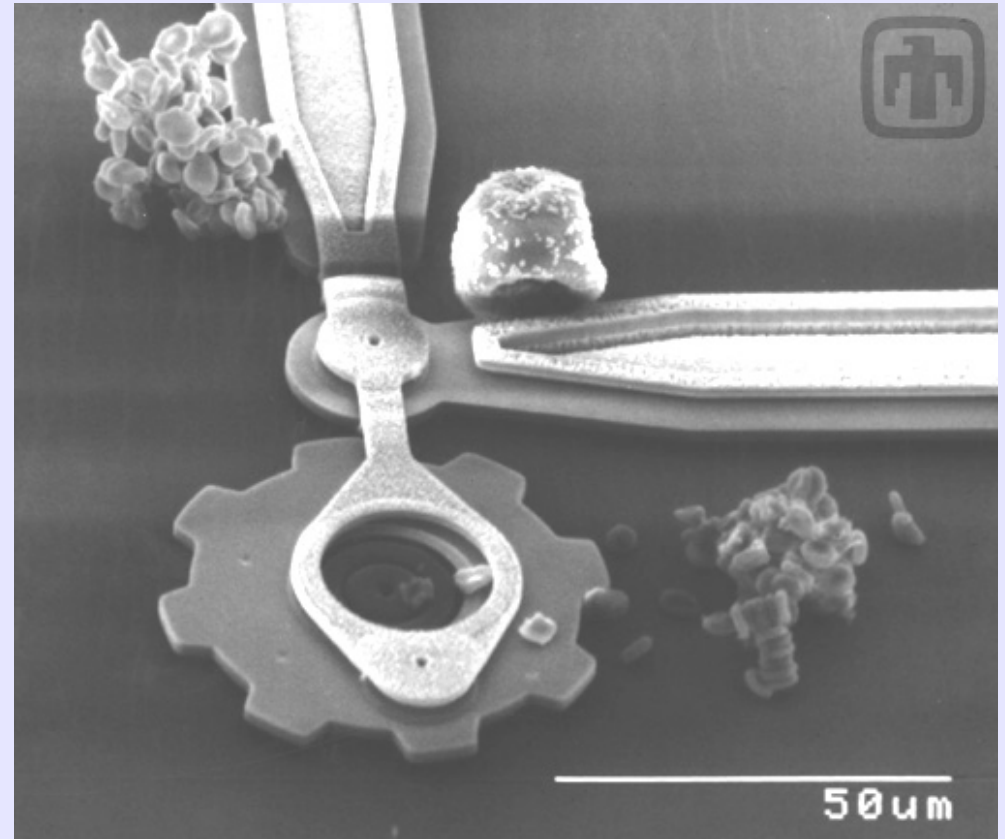
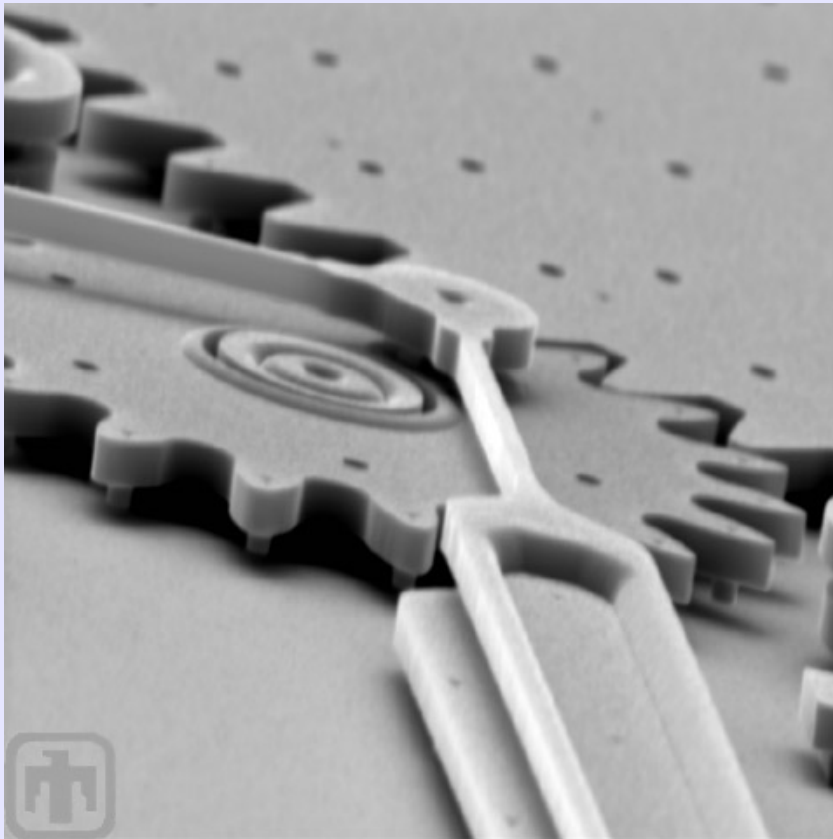

Courtesy of Sandia National Laboratories, SUMMiT™ Technologies, [www.mems.sandia.gov](http://www.mems.sandia.gov)

# actuators: microengines

torque:  $M_i = F_i \cdot r \cdot |\sin \varphi_i|$

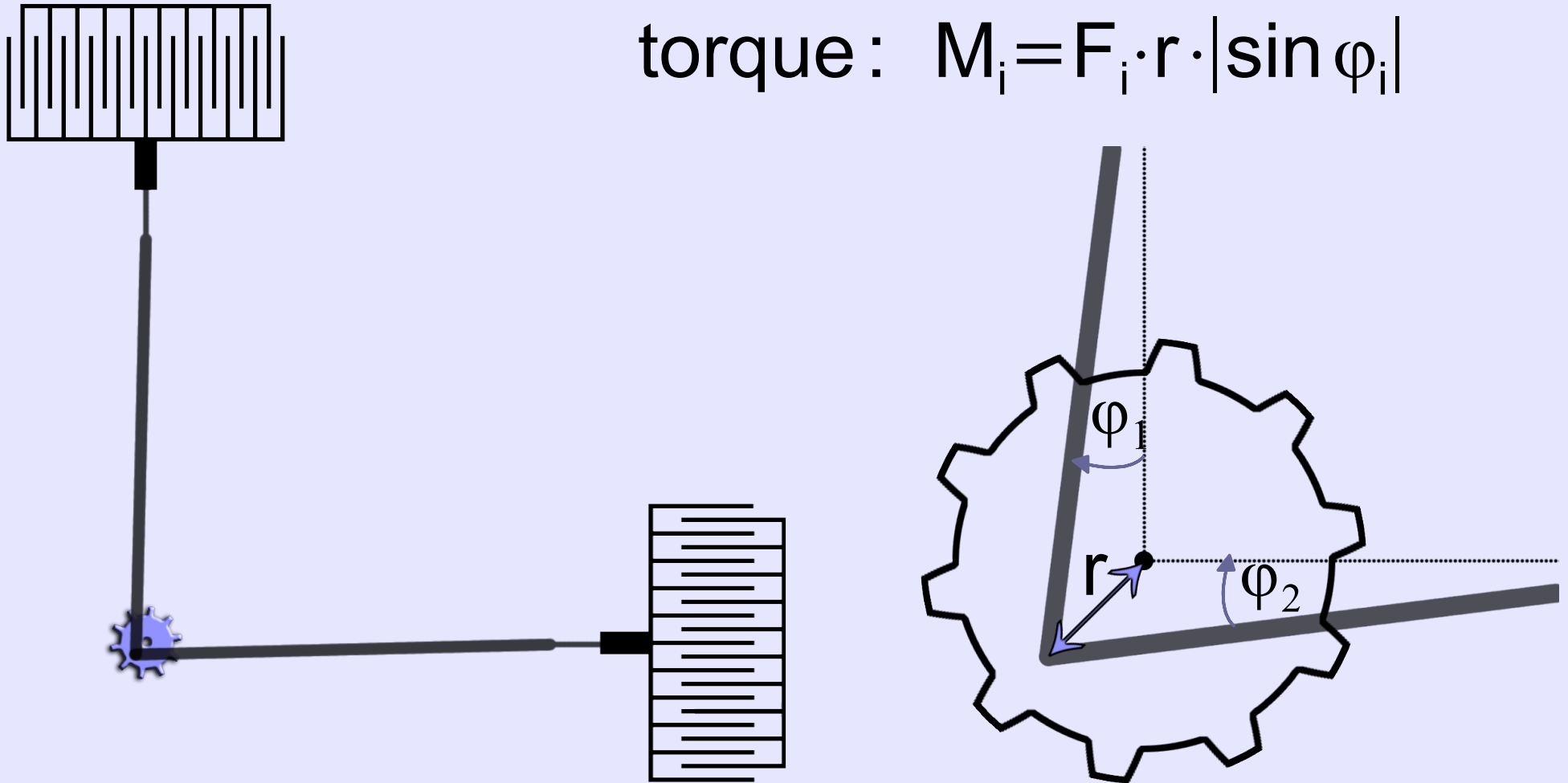

## micropump with piezo actuators

frequency controlled  
flow rate

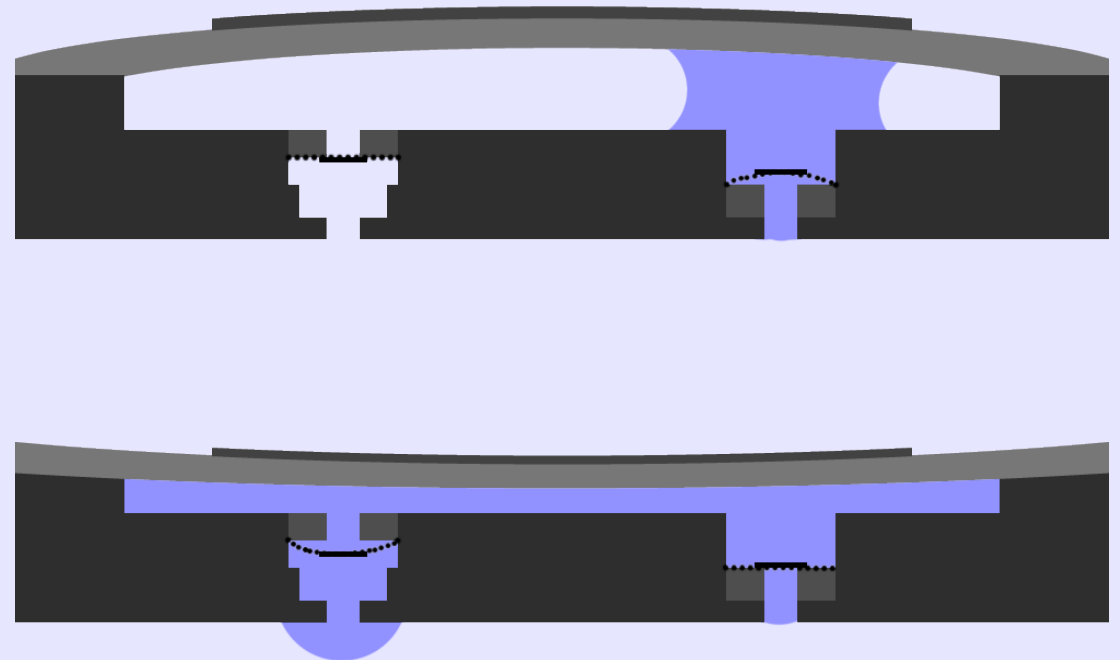

1. introduction
2. definition of MEMS & NEMS
3. active principles
4. types of MEMS
- 5. fabrication**
6. problems with the fabrication

## epitaxial growth

- thermal oxidation ( $\text{SiO}_2$ -layers)
- chemical vapour deposition
- thermal evaporation (metallic layers)
- electrolytic deposition



## chemical vapour deposition (CVD)

e. g. layer of phosphorus-doped silicon

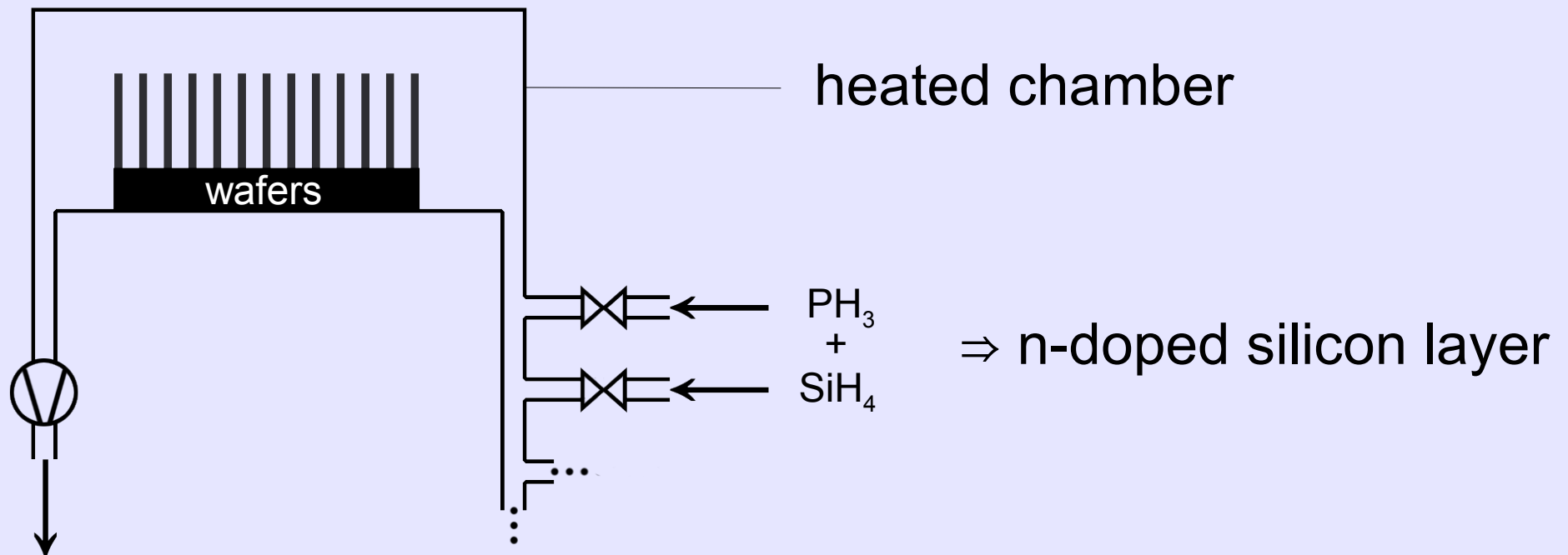

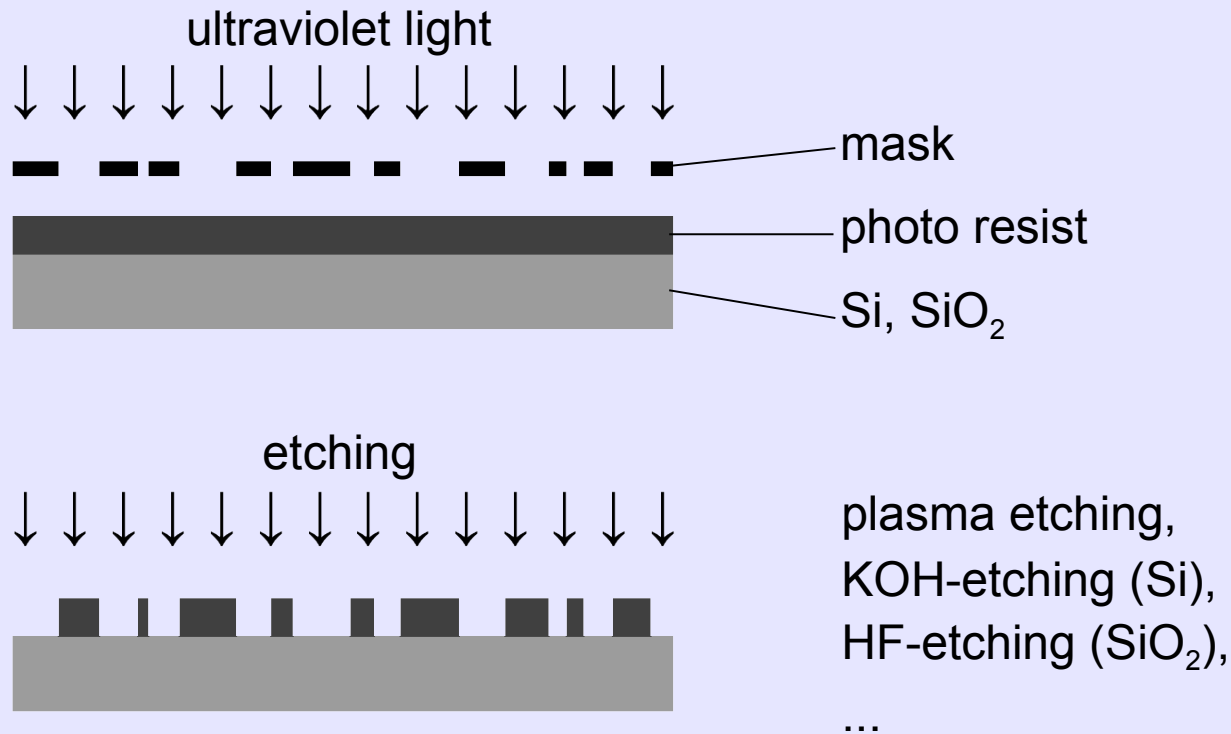

minimum structure width:

ultraviolet light: 1 μm

e-beam, x-ray: <1 μm

## etching

isotropic



e. g.  $\text{SiO}_2$  etched by HF

anisotropic



e. g.  $\langle 100 \rangle$  - Si etched by KOH



e. g. plasma etched Si

## silicon wet etching (e. g. with KOH)

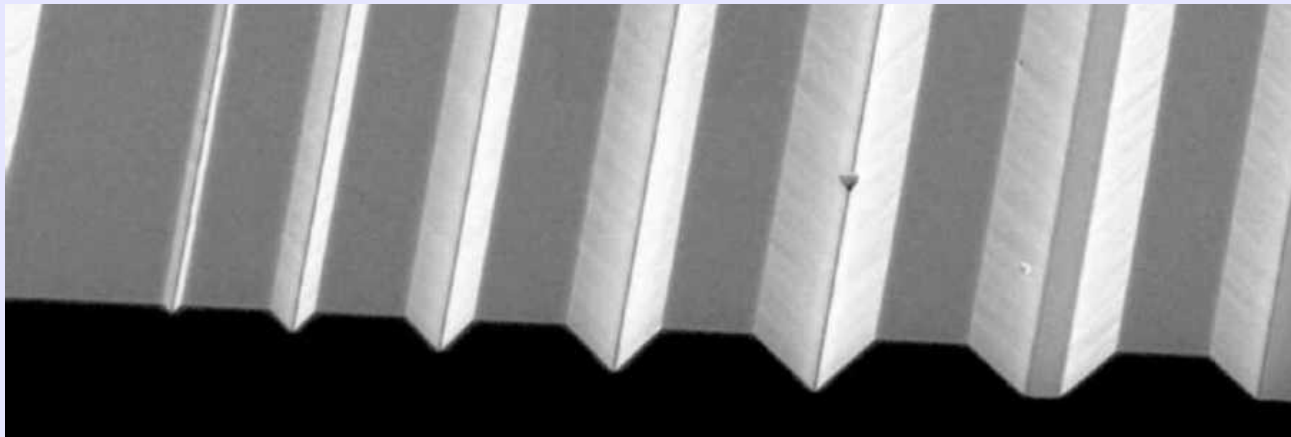

selective etching rate: 
$$\frac{R \{ < 100 > - \text{crystal plane} \}}{R \{ < 111 > - \text{crystal plane} \}} = \frac{30}{1}$$

## silicon wet etching (e. g. with KOH)

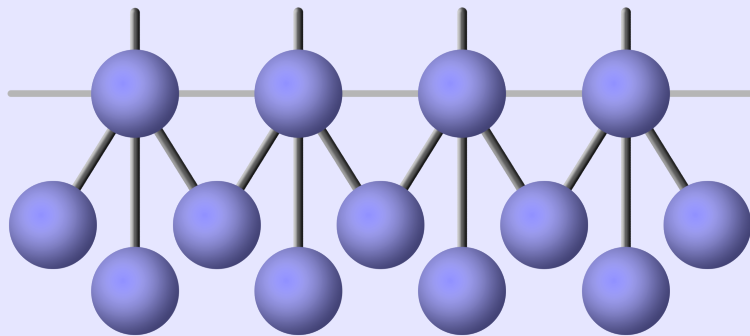
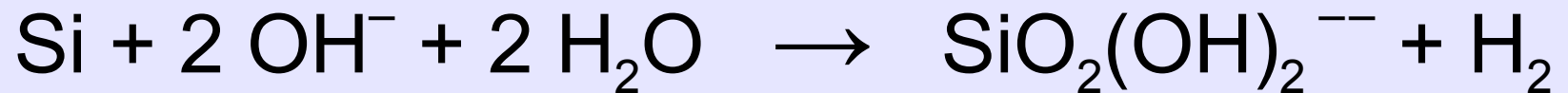

surface structure of <111> - silicon

silicon surface

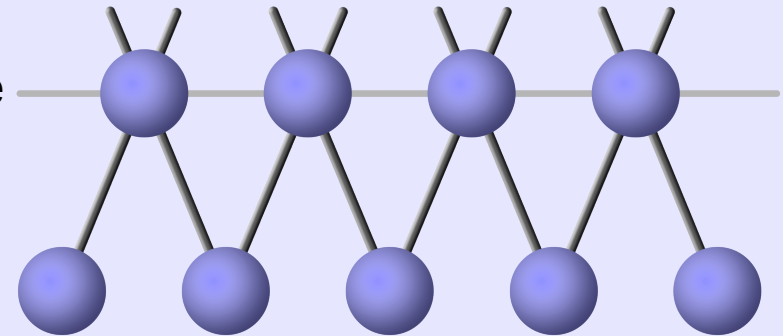

surface structure of <100> - silicon

## reactive ion etching

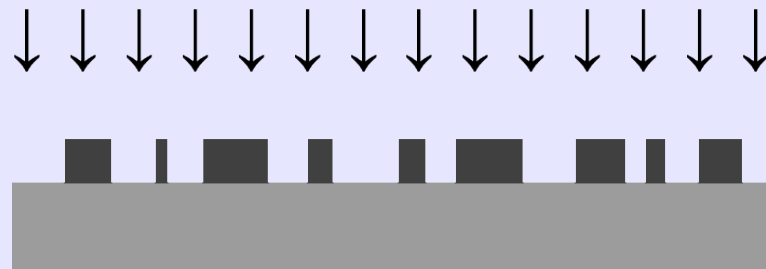

reactive ion etching: combines chemical and physical etching

e. g. fluor ions react with silicon AND heavy ions impact on the surface

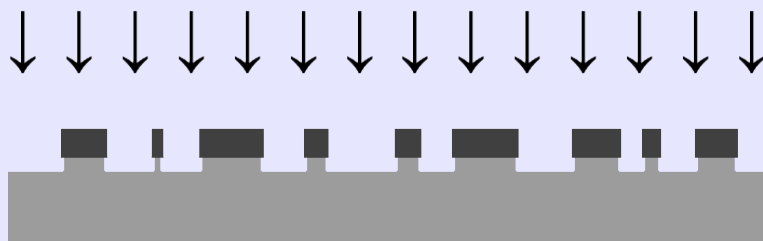

attention: physical etching also attacks the pattern

## reactive ion etching

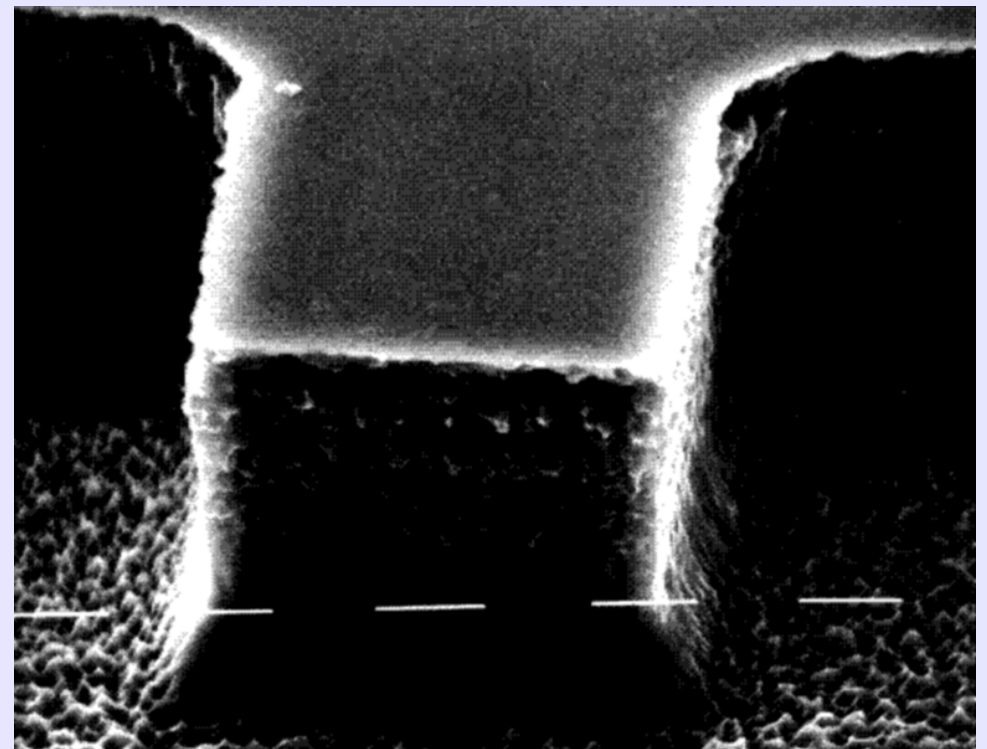
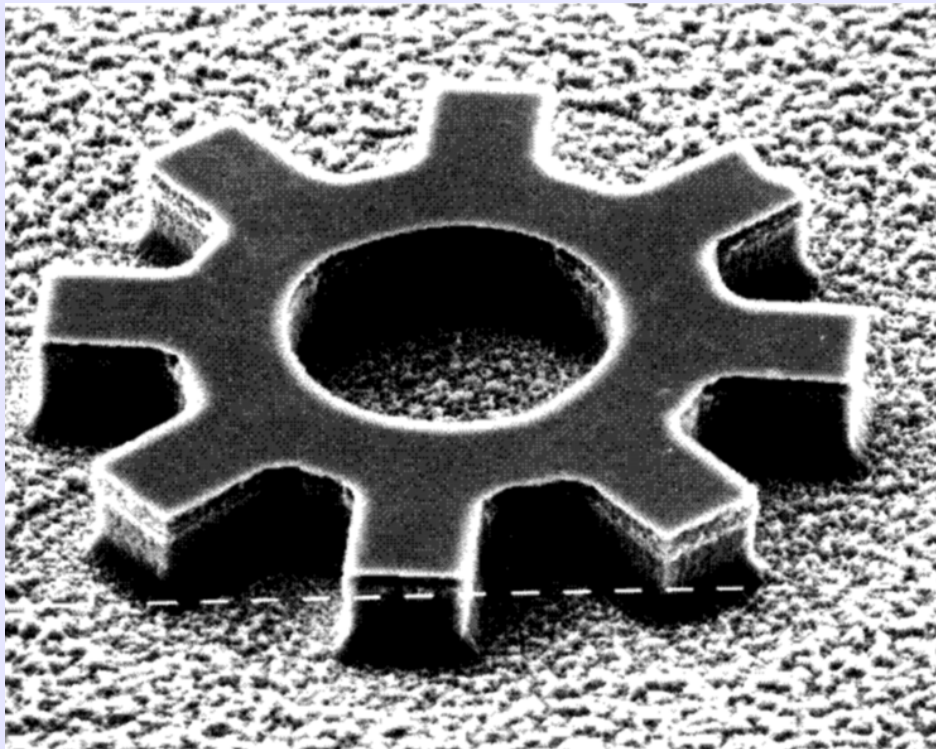

## reactive ion etching

Si:  $\text{SiCl}_4$ ,  $\text{CCl}_4$ ,  $\text{BCl}_3$ ,  $\text{SF}_6$

$\text{SiO}_2$ :  $\text{C}_2\text{F}_6$ ,  $\text{CHF}_3$



1. introduction
2. definition of MEMS & NEMS
3. active principles
4. types of MEMS
5. fabrication
- 6. problems with the fabrication**



# problems with the fabrication

## contamination

- microscopic contaminations (dust)
- molecular dirt:
  - e. g. oil fog from vacuum pumps
  - adhesion degradation of epitaxial layers

## hillocks

KOH-etching: dust particles may result in hillocks

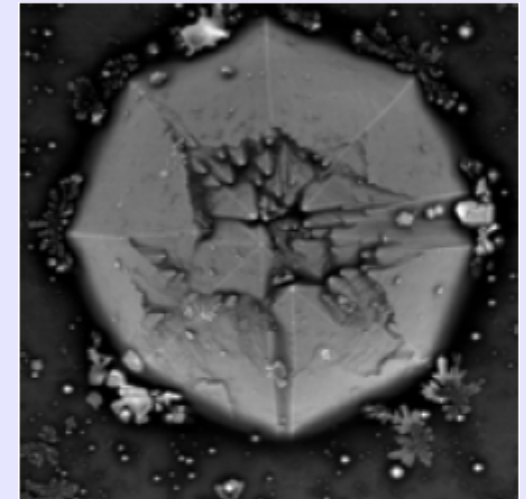
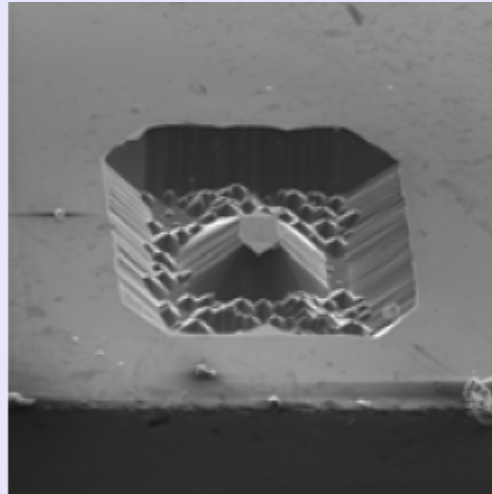
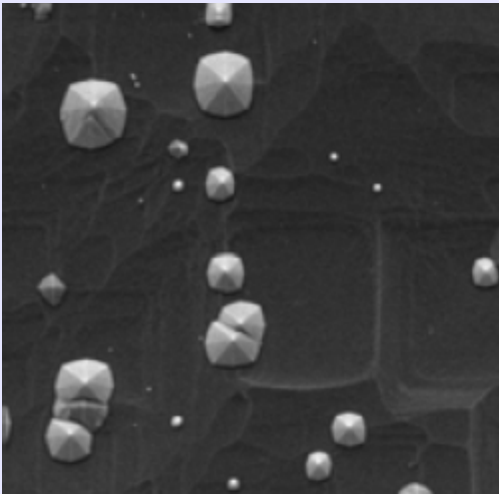



# list of references & picture credits

N. Lobontiu, E. Garcia: *Mechanics of Microelectromechanical Systems*, Kluwer Academic Publishers, 2005

M. Glück: *MEMS in der Mikrosystemtechnik*, B.G. Teubner Verlag, Wiesbaden 2005

M. Elwenspoek, R. Wiegerink: *Mechanical Microsensors*, Springer-Verlag, Berlin 2001

M. Gad-el-Hak (editor): *The MEMS Handbook*, CRC Press, Boca Raton 2006

W. Lachermeier: *Das Labor in der Westentasche*, Mechatronik F&M, 3/2006

<http://mems.sandia.gov>

<http://www.wikipedia.com>

<http://physicsweb.org>

<http://news.bbc.co.uk>

<http://archives.caltech.edu>

<http://www.invensense.com>

<http://mems.cwru.edu>