

Part V

Matchings

Matching

- ▶ Input: undirected graph $G = (V, E)$.
- ▶ $M \subseteq E$ is a **matching** if each node appears in at most one edge in M .
- ▶ Maximum Matching: find a matching of maximum cardinality

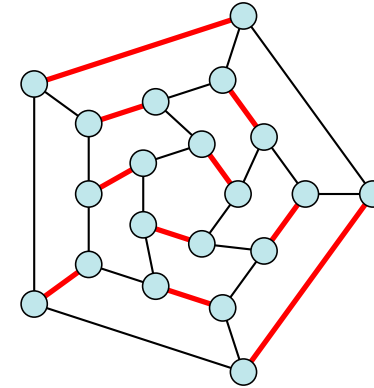

Bipartite Matching

- ▶ Input: undirected, **bipartite** graph $G = (L \cup R, E)$.
- ▶ $M \subseteq E$ is a **matching** if each node appears in at most one edge in M .
- ▶ Maximum Matching: find a matching of maximum cardinality

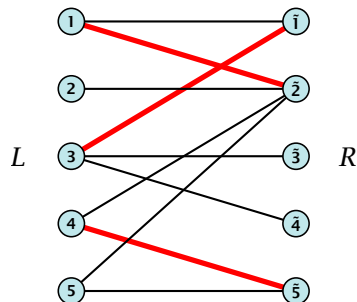

Bipartite Matching

- ▶ Input: undirected, **bipartite** graph $G = (L \cup R, E)$.
- ▶ $M \subseteq E$ is a **matching** if each node appears in at most one edge in M .
- ▶ Maximum Matching: find a matching of maximum cardinality

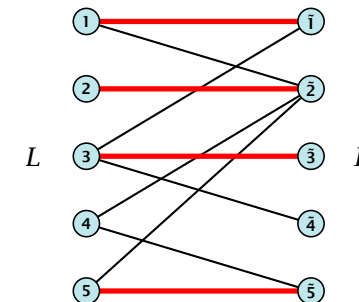

Bipartite Matching

- ▶ A matching M is **perfect** if it is of cardinality $|M| = |V|/2$.
- ▶ For a bipartite graph $G = (L \uplus R, E)$ this means $|M| = |L| = |R| = n$.

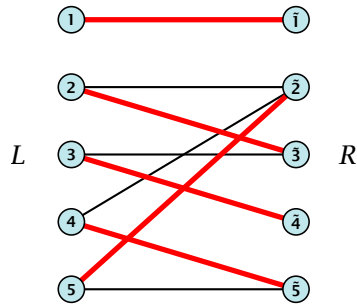

19 Bipartite Matching via Flows

- ▶ Input: undirected, **bipartite** graph $G = (L \uplus R \uplus \{s, t\}, E')$.
- ▶ Direct all edges from L to R .
- ▶ Add source s and connect it to all nodes on the left.
- ▶ Add t and connect all nodes on the right to t .
- ▶ All edges have unit capacity.

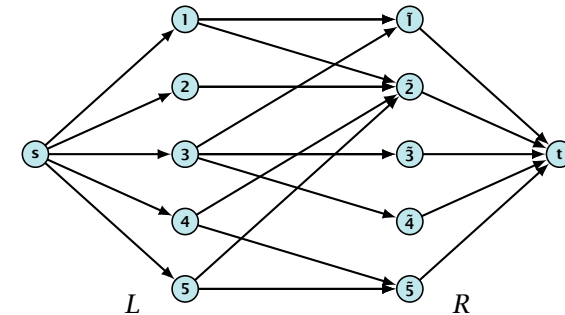

Proof

Max cardinality matching in $G \leq$ value of maxflow in G'

- ▶ Given a maximum matching M of cardinality k .
- ▶ Consider flow f that sends one unit along each of k paths.
- ▶ f is a flow and has cardinality k .

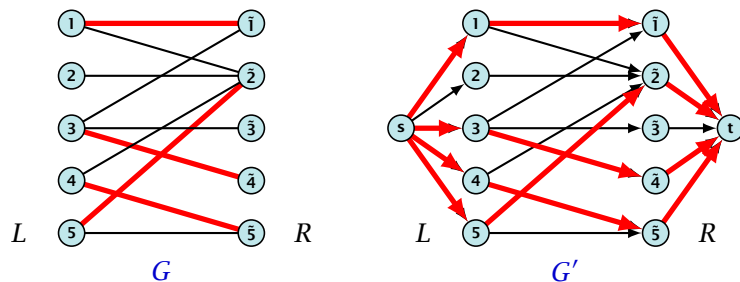

Proof

Max cardinality matching in $G \geq$ value of maxflow in G'

- ▶ Let f be a maxflow in G' of value k
- ▶ Integrality theorem $\Rightarrow k$ integral; we can assume f is 0/1.
- ▶ Consider $M =$ set of edges from L to R with $f(e) = 1$.
- ▶ Each node in L and R participates in at most one edge in M .
- ▶ $|M| = k$, as the flow must use at least k middle edges.

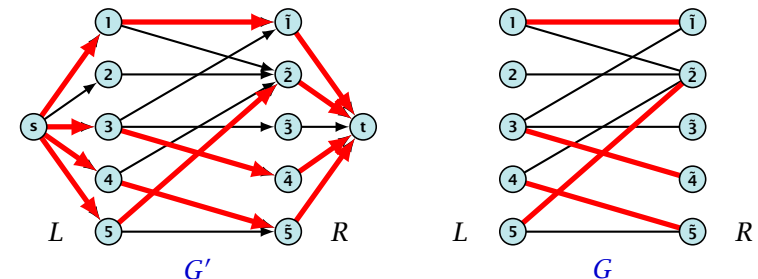

19 Bipartite Matching via Flows

Which flow algorithm to use?

- ▶ Generic augmenting path: $\mathcal{O}(m \cdot \text{val}(f^*)) = \mathcal{O}(mn)$.
- ▶ Capacity scaling: $\mathcal{O}(m^2 \log C) = \mathcal{O}(m^2)$.

20 Augmenting Paths for Matchings

Definitions.

- ▶ Given a matching M in a graph G , a vertex that is not incident to any edge of M is called a **free vertex** w. r. t. M .
- ▶ For a matching M a path P in G is called an **alternating path** if edges in M alternate with edges not in M .
- ▶ An alternating path is called an **augmenting path** for matching M if it ends at distinct free vertices.

Theorem 95

A matching M is a maximum matching if and only if there is no augmenting path w. r. t. M .

Augmenting Paths in Action

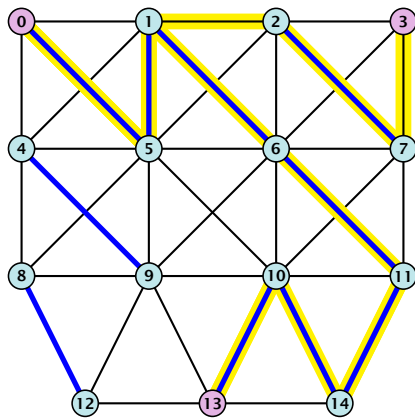

20 Augmenting Paths for Matchings

Proof.

- ⇒ If M is maximum there is no augmenting path P , because we could switch matching and non-matching edges along P . This gives matching $M' = M \oplus P$ with larger cardinality.
- ⇐ Suppose there is a matching M' with larger cardinality. Consider the graph H with edge-set $M' \oplus M$ (i.e., only edges that are in either M or M' but not in both).

Each vertex can be incident to at most two edges (one from M and one from M'). Hence, the connected components are alternating cycles or alternating path.

As $|M'| > |M|$ there is one connected component that is a path P for which both endpoints are incident to edges from M' . P is an alternating path.

20 Augmenting Paths for Matchings

Algorithmic idea:

As long as you find an augmenting path augment your matching using this path. When you arrive at a matching for which no augmenting path exists you have a maximum matching.

Theorem 96

Let G be a graph, M a matching in G , and let u be a free vertex w.r.t. M . Further let P denote an augmenting path w.r.t. M and let $M' = M \oplus P$ denote the matching resulting from augmenting M with P . If there was no augmenting path starting at u in M then there is no augmenting path starting at u in M' .

The above theorem allows for an easier implementation of an augmenting path algorithm. Once we checked for augmenting paths starting from u we don't have to check for such paths in future rounds.

20 Augmenting Paths for Matchings

Proof

- ▶ Assume there is an augmenting path P' w.r.t. M' starting at u .
- ▶ If P' and P are node-disjoint, P' is also augmenting path w.r.t. M (\neq).
- ▶ Let u' be the **first** node on P' that is in P , and let e be the matching edge from M' incident to u' .
- ▶ u' splits P into two parts one of which does not contain e . Call this part P_1 . Denote the sub-path of P' from u to u' with P'_1 .
- ▶ $P_1 \circ P'_1$ is augmenting path in M (\neq).

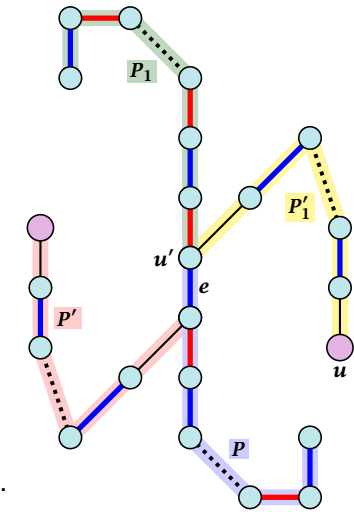

How to find an augmenting path?

Construct an alternating tree.

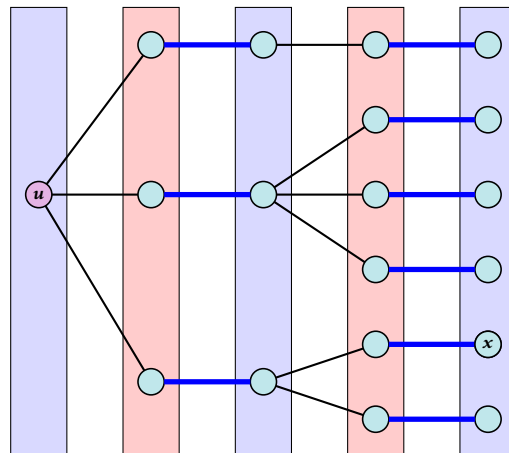

even nodes
odd nodes

Case 1:
 y is free vertex not contained in T

you found alternating path

How to find an augmenting path?

Construct an alternating tree.

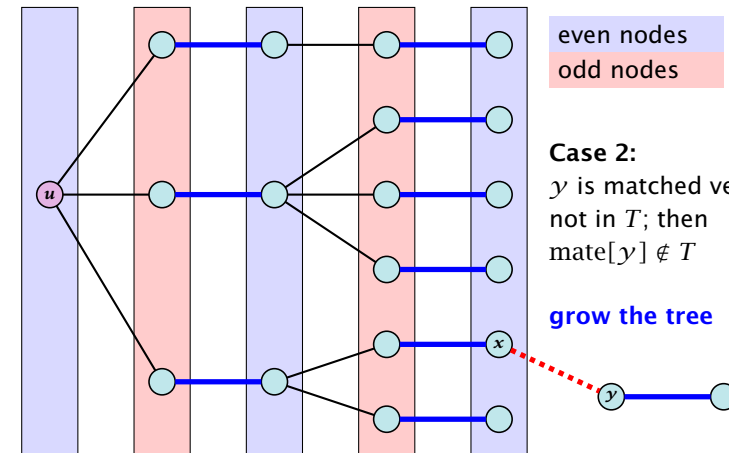

even nodes
odd nodes

Case 2:
 y is matched vertex not in T ; then $\text{mate}[y] \notin T$

grow the tree

How to find an augmenting path?

Construct an alternating tree.

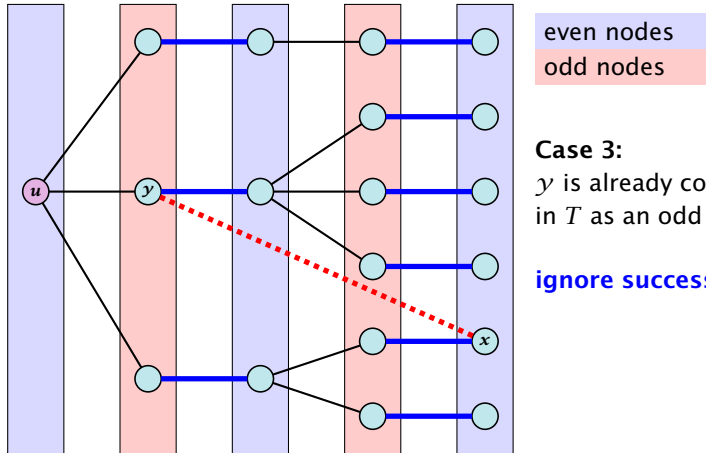

Case 3:
 y is already contained
in T as an odd vertex

ignore successor y

How to find an augmenting path?

Construct an alternating tree.

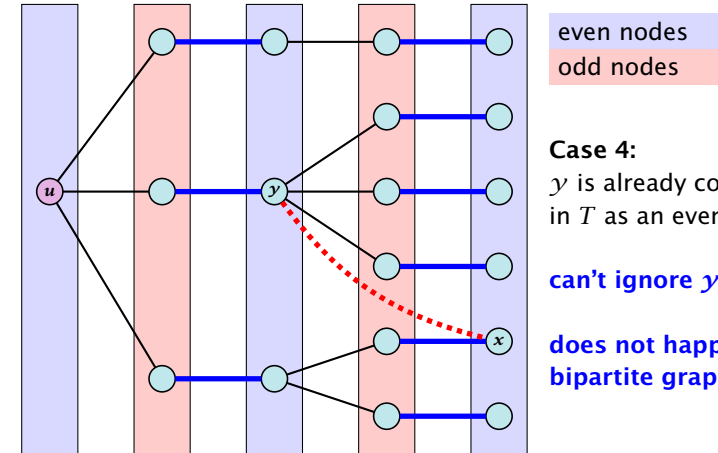

Case 4:
 y is already contained
in T as an even vertex

can't ignore y

does not happen in
bipartite graphs

Algorithm 1 BiMatch($G, match$)

```

1: for  $x \in V$  do  $mate[x] \leftarrow 0$ ;
2:  $r \leftarrow 0$ ;  $free \leftarrow n$ ;
3: while  $free \geq 1$  and  $r < n$  do
4:    $r \leftarrow r + 1$ 
5:   if  $mate[r] = 0$  then
6:     for  $i = 1$  to  $m$  do  $parent[i'] \leftarrow 0$ 
7:      $Q \leftarrow \emptyset$ ;  $Q.append(r)$ ;  $aug \leftarrow false$ ;
8:     while  $aug = false$  and  $Q \neq \emptyset$  do
9:        $x \leftarrow Q.dequeue()$ ;
10:      if  $\exists y \in A_x: mate[y] = 0$  then
11:        augment( $mate, parent, y$ );
12:         $aug \leftarrow true$ ;  $free \leftarrow free - 1$ ;
13:      else
14:        if  $parent[y] = 0$  then
15:           $parent[y] \leftarrow x$ ;
16:           $Q.enqueue(y)$ ;
    
```

graph $G = (S \cup S', E)$;
 $S = \{1, \dots, n\}$;
 $S = \{1', \dots, n'\}$

initial matching empty

$free$: number of
unmatched nodes in S

r : root of current tree

if r is unmatched
start tree construction

initialize empty tree

no augmen. path but
unexamined leaves

free neighbour found

add new node y to Q

21 Weighted Bipartite Matching

Weighted Bipartite Matching/Assignment

- ▶ Input: undirected, bipartite graph $G = L \cup R, E$.
- ▶ an edge $e = (\ell, r)$ has weight $w_e \geq 0$
- ▶ find a matching of maximum weight, where the weight of a matching is the sum of the weights of its edges

Simplifying Assumptions (wlog [why?]):

- ▶ assume that $|L| = |R| = n$
- ▶ assume that there is an edge between every pair of nodes $(\ell, r) \in V \times V$

Weighted Bipartite Matching

Theorem 97 (Halls Theorem)

A bipartite graph $G = (L \cup R, E)$ has a perfect matching if and only if for all sets $S \subseteq L$, $|\Gamma(S)| \geq |S|$, where $\Gamma(S)$ denotes the set of nodes in R that have a neighbour in S .

Halls Theorem

Proof:

- ← Of course, the condition is necessary as otherwise not all nodes in S could be matched to different neighbours.
- ⇒ For the other direction we need to argue that the minimum cut in the graph G' is at least $|L|$.
 - ▶ Let S denote a minimum cut and let $L_S \triangleq L \cap S$ and $R_S \triangleq R \cap S$ denote the portion of S inside L and R , respectively.
 - ▶ Clearly, all neighbours of nodes in L_S have to be in S , as otherwise we would cut an edge of infinite capacity.
 - ▶ This gives $R_S \geq |\Gamma(L_S)|$.
 - ▶ The size of the cut is $|L| - |L_S| + |R_S|$.
 - ▶ Using the fact that $|\Gamma(L_S)| \geq |L_S|$ gives that this is at least $|L|$.

Algorithm Outline

Idea:

We introduce a node weighting \vec{x} . Let for a node $v \in V$, $x_v \geq 0$ denote the weight of node v .

- ▶ Suppose that the node weights dominate the edge-weights in the following sense:

$$x_u + x_v \geq w_e \text{ for every edge } e = (u, v).$$

- ▶ Let $H(\vec{x})$ denote the subgraph of G that only contains edges that are **tight** w.r.t. the node weighting \vec{x} , i.e. edges $e = (u, v)$ for which $w_e = (u, v)$.
- ▶ Try to compute a perfect matching in the subgraph $H(\vec{x})$. If you are successful you found an optimal matching.

Algorithm Outline

Reason:

- ▶ The weight of your matching M^* is

$$\sum_{(u,v) \in M^*} w_{(u,v)} = \sum_{(u,v) \in M^*} (x_u + x_v) = \sum_v x_v .$$

- ▶ Any other matching M has

$$\sum_{(u,v) \in M} w_{(u,v)} \leq \sum_{(u,v) \in M} (x_u + x_v) \leq \sum_v x_v .$$

Algorithm Outline

What if you don't find a perfect matching?

Then, Halls theorem guarantees you that there is a set $S \subseteq L$, with $|\Gamma(S)| < |S|$, where Γ denotes the neighbourhood w.r.t. the subgraph $H(\vec{x})$.

Idea: reweight such that:

- ▶ the total weight assigned to nodes decreases
- ▶ the weight function still dominates the edge-weights

If we can do this we have an algorithm that terminates with an optimal solution (we analyze the running time later).

Changing Node Weights

Increase node-weights in $\Gamma(S)$ by $+\delta$, and decrease the node-weights in S by $-\delta$.

- ▶ Total node-weight decreases.
- ▶ Only edges from S to $R - \Gamma(S)$ decrease in their weight.
- ▶ Since, none of these edges is tight (otw. the edge would be contained in $H(\vec{x})$, and hence would go between S and $\Gamma(S)$) we can do this decrement for small enough $\delta > 0$ until a new edge gets tight.

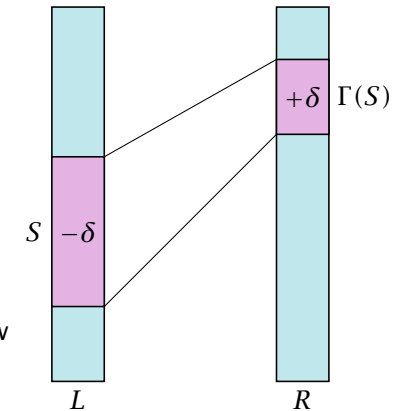

Weighted Bipartite Matching

Edges not drawn have weight 0.

$$\delta = 1 \quad \delta = 1$$

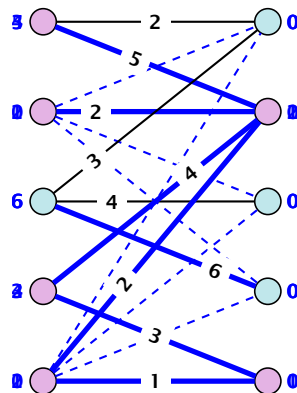

Analysis

How many iterations do we need?

- ▶ One reweighting step increases the number of edges out of S by at least one.
- ▶ Assume that we have a maximum matching that saturates the set $\Gamma(S)$, in the sense that every node in $\Gamma(S)$ is matched to a node in S (we will show that we can always find S and a matching such that this holds).
- ▶ This matching is still contained in the new graph, because all its edges either go between $\Gamma(S)$ and S or between $L - S$ and $R - \Gamma(S)$.
- ▶ Hence, reweighting does not decrease the size of a maximum matching in the tight sub-graph.

Analysis

- ▶ We will show that after at most n reweighting steps the size of the maximum matching can be increased by finding an augmenting path.
- ▶ This gives a polynomial running time.

Analysis

How do we find S ?

- ▶ Start on the left and compute an alternating tree, starting at any free node u .
- ▶ If this construction stops, there is no perfect matching in the tight subgraph (because for a perfect matching we need to find an augmenting path starting at u).
- ▶ The set of even vertices is on the left and the set of odd vertices is on the right **and** contains all neighbours of even nodes.
- ▶ All odd vertices are matched to even vertices. Furthermore, the even vertices additionally contain the free vertex u . Hence, $|V_{\text{odd}}| = |\Gamma(V_{\text{even}})| < |V_{\text{even}}|$, and all odd vertices are saturated in the current matching.

Analysis

- ▶ The current matching does not have any edges from V_{odd} to outside of $L \setminus V_{\text{even}}$ (edges that may possibly be deleted by changing weights).
- ▶ After changing weights, there is at least one more edge connecting V_{even} to a node outside of V_{odd} . After at most n reweightings we can do an augmentation.
- ▶ A reweighting can be trivially performed in time $\mathcal{O}(n^2)$ (keeping track of the tight edges).
- ▶ An augmentation takes at most $\mathcal{O}(n)$ time.
- ▶ In total we obtain a running time of $\mathcal{O}(n^4)$.
- ▶ A more careful implementation of the algorithm obtains a running time of $\mathcal{O}(n^3)$.

A Fast Matching Algorithm

Algorithm 54 Bimatch-Hopcroft-Karp(G)

```
1:  $M \leftarrow \emptyset$ 
2: repeat
3:   let  $\mathcal{P} = \{P_1, \dots, P_k\}$  be maximal set of
4:   vertex-disjoint, shortest augmenting paths w.r.t.  $M$ .
5:    $M \leftarrow M \oplus (P_1 \cup \dots \cup P_k)$ 
6: until  $\mathcal{P} = \emptyset$ 
7: return  $M$ 
```

We call one iteration of the repeat-loop a **phase** of the algorithm.

Analysis

Lemma 98

Given a matching M and a maximal matching M^* there exist $|M^*| - |M|$ *vertex-disjoint* augmenting paths w.r.t. M .

Proof:

- ▶ Similar to the proof that a matching is optimal iff it does not contain an augmenting paths.
- ▶ Consider the graph $G = (V, M \oplus M^*)$, and mark edges in this graph blue if they are in M and red if they are in M^* .
- ▶ The connected components of G are cycles and paths.
- ▶ The graph contains $k \stackrel{\text{def}}{=} |M^*| - |M|$ more red edges than blue edges.
- ▶ Hence, there are at least k components that form a path starting and ending with a blue edge. These are augmenting paths w.r.t. M .

Analysis

- ▶ Let P_1, \dots, P_k be a maximal collection of vertex-disjoint, shortest augmenting paths w.r.t. M (let $\ell = |P_i|$).
- ▶ $M' \stackrel{\text{def}}{=} M \oplus (P_1 \cup \dots \cup P_k) = M \oplus P_1 \oplus \dots \oplus P_k$.
- ▶ Let P be an augmenting path in M' .

Lemma 99

The set $A \stackrel{\text{def}}{=} M \oplus (M' \oplus P) = (P_1 \cup \dots \cup P_k) \oplus P$ contains at least $(k + 1)\ell$ edges.

Analysis

Proof.

- ▶ The set describes exactly the symmetric difference between matchings M and $M' \oplus P$.
- ▶ Hence, the set contains at least $k + 1$ vertex-disjoint augmenting paths w.r.t. M as $|M'| = |M| + k + 1$.
- ▶ Each of these paths is of length at least ℓ .

Analysis

Lemma 100

P is of length at least $\ell + 1$. This shows that the length of a shortest augmenting path increases between two phases of the Hopcroft-Karp algorithm.

Proof.

- ▶ If P does not intersect any of the P_1, \dots, P_k , this follows from the maximality of the set $\{P_1, \dots, P_k\}$.
- ▶ Otherwise, at least one edge from P coincides with an edge from paths $\{P_1, \dots, P_k\}$.
- ▶ This edge is not contained in A .
- ▶ Hence, $|A| \leq k\ell + |P| - 1$.
- ▶ The lower bound on $|A|$ gives $(k + 1)\ell \leq |A| \leq k\ell + |P| - 1$, and hence $|P| \geq \ell + 1$.

Analysis

If the shortest augmenting path w.r.t. a matching M has ℓ edges then the cardinality of the maximum matching is of size at most $|M| + \lfloor \frac{|V|}{\ell+1} \rfloor$.

Proof.

The symmetric difference between M and M^* contains $|M^*| - |M|$ vertex-disjoint augmenting paths. Each of these paths contains at least $\ell + 1$ vertices. Hence, there can be at most $\lfloor \frac{|V|}{\ell+1} \rfloor$ of them.

Analysis

Lemma 101

The Hopcroft-Karp algorithm requires at most $2\sqrt{|V|}$ phases.

Proof.

- ▶ After iteration $\lfloor \sqrt{|V|} \rfloor$ the length of a shortest augmenting path must be at least $\lfloor \sqrt{|V|} \rfloor + 1 \geq \sqrt{|V|}$.
- ▶ Hence, there can be at most $|V| / (\sqrt{|V|} + 1) \leq \sqrt{|V|}$ additional augmentations.

Analysis

Lemma 102

One phase of the Hopcroft-Karp algorithm can be implemented in time $\mathcal{O}(m)$.

How to find an augmenting path?

Construct an alternating tree.

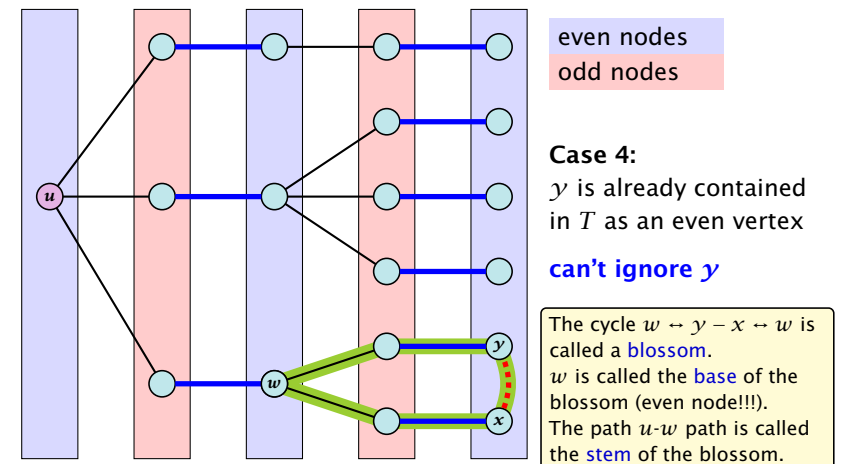

Flowers and Blossoms

Definition 103

A **flower** in a graph $G = (V, E)$ w.r.t. a matching M and a (free) root node r , is a subgraph with two components:

- ▶ A **stem** is an even length alternating path that starts at the root node r and terminates at some node w . We permit the possibility that $r = w$ (empty stem).
- ▶ A **blossom** is an odd length alternating cycle that starts and terminates at the terminal node w of a stem and has no other node in common with the stem. w is called the **base** of the blossom.

Flowers and Blossoms

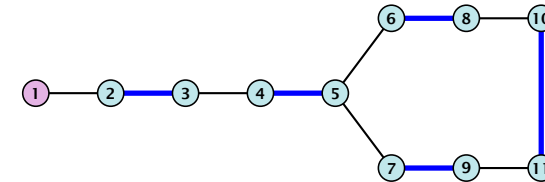
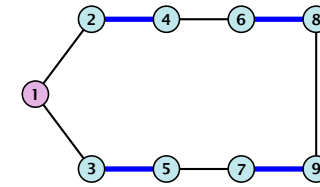

Flowers and Blossoms

Properties:

1. A stem spans $2\ell + 1$ nodes and contains ℓ matched edges for some integer $\ell \geq 0$.
2. A blossom spans $2k + 1$ nodes and contains k matched edges for some integer $k \geq 1$. The matched edges match all nodes of the blossom except the base.
3. The base of a blossom is an even node (if the stem is part of an alternating tree starting at r).

Flowers and Blossoms

Properties:

4. Every node x in the blossom (except its base) is reachable from the root (or from the base of the blossom) through two distinct alternating paths; one with even and one with odd length.
5. The even alternating path to x terminates with a matched edge and the odd path with an unmatched edge.

Flowers and Blossoms

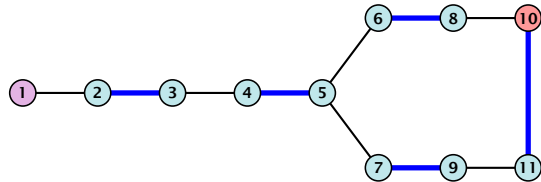

When during the alternating tree construction we discover a blossom B we replace the graph G by $G' = G/B$, which is obtained from G by contracting the blossom B .

- ▶ Delete all vertices in B (and its incident edges) from G .
- ▶ Add a new (pseudo-)vertex b . The new vertex b is connected to all vertices in $V \setminus B$ that had at least one edge to a vertex from B .

Shrinking Blossoms

- ▶ Edges of T that connect a node u not in B to a node in B become tree edges in T' connecting u to b .
- ▶ Matching edges (there is at most one) that connect a node u not in B to a node in B become matching edges in M' .
- ▶ Nodes that are connected in G to at least one node in B become connected to b in G' .

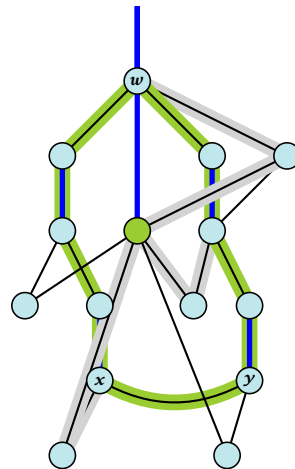

Algorithm 55 search($r, found$)

```

1: set  $\bar{A}(i) \leftarrow A(i)$  for all nodes  $i$ 
2:  $found \leftarrow false$ 
3: unlabeled all nodes;
4: give an even label to  $r$  and initialize  $list \leftarrow \{r\}$ 
5: while  $list \neq \emptyset$  do
6:   delete a node  $i$  from  $list$ 
7:   examine( $i, found$ )
8:   if  $found = true$  then
9:     return

```

Algorithm 56 $\text{examine}(i, \text{found})$

```

1: for all  $j \in \bar{A}(i)$  do
2:   if  $j$  is even then  $\text{contract}(i, j)$  and return
3:   if  $j$  is unmatched then
4:      $q \leftarrow j$ ;
5:      $\text{pred}(q) \leftarrow i$ ;
6:      $\text{found} \leftarrow \text{true}$ ;
7:     return
8:   if  $j$  is matched and unlabeled then
9:      $\text{pred}(j) \leftarrow i$ ;
10:     $\text{pred}(\text{mate}(j)) \leftarrow j$ ;

```

Algorithm 57 $\text{contract}(i, j)$

```

1: trace pred-indices of  $i$  and  $j$  to identify a blossom  $B$ 
2: create new node  $b$  and set  $\bar{A}(b) \leftarrow \cup_{x \in B} \bar{A}(x)$ 
3: label  $b$  even and add to list
4: update  $\bar{A}(j) \leftarrow \bar{A}(j) \cup \{b\}$  for each  $j \in \bar{A}(b)$ 
5: form a circular doubly linked list of nodes in  $B$ 
6: delete nodes in  $B$  from the graph

```

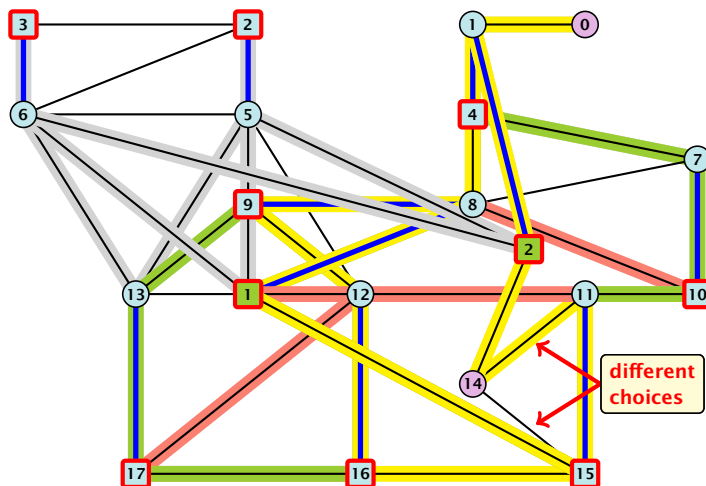
Example: Blossom Algorithm

Assume that we have contracted a blossom B w.r.t. a matching M whose base is w . We created graph $G' = G/B$ with pseudonode b . Let M' be the matching in the contracted graph.

Lemma 104

If G' contains an augmenting path p' starting at r (or the pseudo-node containing r) w.r.t. to the matching M' then G contains an augmenting path starting at r w.r.t. matching M .

Proof.

If p' does not contain b it is also an augmenting path in G .

Case 1: non-empty stem

- ▶ Next suppose that the stem is non-empty.

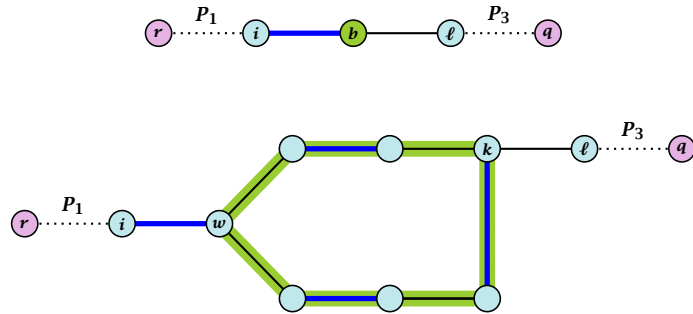

- ▶ After the expansion ℓ must be incident to some node in the blossom. Let this node be k .
- ▶ If $k \neq w$ there is an alternating path P_2 from w to k that ends in a matching edge.
- ▶ $P_1 \circ (i, w) \circ P_2 \circ (k, \ell) \circ P_3$ is an alternating path.
- ▶ If $k = w$ then $P_1 \circ (i, w) \circ (w, \ell) \circ P_3$ is an alternating path.

Proof.

Case 2: empty stem

- ▶ If the stem is empty then after expanding the blossom, $w = r$.

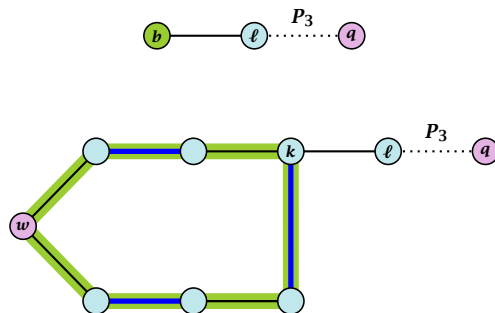

- ▶ The path $r \circ P_2 \circ (k, \ell) \circ P_3$ is an alternating path.

Lemma 105

If G contains an augmenting path P from r to q w.r.t. matching M then G' contains an augmenting path from r (or the pseudo-node containing r) to q w.r.t. M' .

Proof.

- ▶ If P does not contain a node from B there is nothing to prove.
- ▶ We can assume that r and q are the only free nodes in G .

Case 1: empty stem

Let i be the last node on the path P that is part of the blossom.

P is of the form $P_1 \circ (i, j) \circ P_2$, for some node j and (i, j) is unmatched.

$(b, j) \circ P_2$ is an augmenting path in the contracted network.

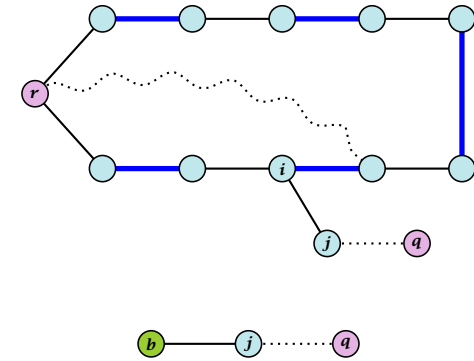

Case 2: non-empty stem

Let P_3 be alternating path from r to w . Define $M_+ = M \oplus P_3$.

In M_+ , r is matched and w is unmatched.

G must contain an augmenting path w.r.t. matching M_+ , since M and M_+ have same cardinality.

This path must go between w and q as these are the only unmatched vertices w.r.t. M_+ .

For M'_+ the blossom has an empty stem. Case 1 applies.

G' has an augmenting path w.r.t. M'_+ . It must also have an augmenting path w.r.t. M' , as both matchings have the same cardinality.

This path must go between r and q .

Example: Blossom Algorithm

